

The Solero logo features a red sun icon above the brand name "Solero" in a white, sans-serif font. The background of the entire advertisement is a high-quality photograph of a modern outdoor lounge area. It includes a large, square, cream-colored patio umbrella with a silver metal frame, a white modular sofa with light-colored cushions, and a wooden coffee table. The setting is a bright, sunny day with palm trees and a modern white building in the background.

Solero®

QUALITY THAT STANDS
THE PASSING OF TIME

2022
WWW.PARASOLS.COM

GREEN BUSINESS PARTNER OF TREES FOR ALL SINCE 2020









TABLE OF CONTENTS

SOLERO COLLECTION

Sublimo Pro 200x200 Ø300	 	04
Vaticano Pro Ø250		08
Teatro Pro Ø270		12
Cielo Pro 260x260		16
Laterna Pro 300x300 Ø350		20
Fratello Pro 300x300		24
Fuerto Pro 300x300	 	28
Patio Pro 300x300	 	32
Lasagna Pro Ø330	 	36
Presto Pro 330x330 Ø400	 	40
Palestro Pro 300x400 400x400		44
Maestro Pro 300x400 400x400	 	48
Basto Pro 400x400 500x500	 	52

PROSTOR COLLECTION

P4 Pro Ø270		56
P6 Pro 2.5x2.5m 3x3m Ø350 Ø420	 	60
P7 Pro 2.5x2.5m 3x3m Ø350 Ø420	 	64

HEATERS & LIGHTING	68
--------------------	----

GUTTERS, COVERS & CLOTHS	74
--------------------------	----

PRINTING	78
----------	----

FASTENING METHODS	82
-------------------	----

PORTFOLIO	84
-----------	----

O'BRAVIA CLOTH	86
----------------	----

ANCHOR & FEET POSITIONING	88
---------------------------	----

SOLERO & TREES FOR ALL	90
------------------------	----

TERMS & CONDITIONS	92
--------------------	----

BREATH IN

At the beginning of 2020, we became a forest partner of Trees For All, not knowing that clean air would be of such importance in the pandemic. Together with all inhabitants of planet earth, we held our breath.

The 1.5-meter society is crying out for space and ventilation, two things in which we can play a fulfilling role with our products. Because while doors take turns closing, the desire to be outdoors grows ever greater. Shaping the answer to this desire is a challenge that we seize with both (disinfected) hands.

BREATH OUT

The internal processes had to be adapted here and there to make everything run even safer. Receiving people in lots in the showroom and remotely helping them instinctively went against our principles, but the health of our employees and customers always comes first. With some adjustments, everything could still go ahead, which gave us peace of mind.

LET GO

Anticipating a situation like this is like hoping for good weather with a warehouse full of umbrellas on a rainy day. Sometimes we have to let go and wait and see what happens. Trust in the fact that we always do what we can, often even more. After all, after rain comes sunshine.

Our warmest regards, Helga van Keulen – General Director





SOLERO® SUBLIMO PRO

The Sublimo has a contemporary and sleek design with beautiful lines that instantly adds a dimension to your garden, balcony or terrace. This trendy parasol is equipped with four crossed ribs and is incredibly easy to operate. The Sublimo truly stands out above the crowd.

Each Solero parasol has its own character, and that certainly goes for the Sublimo. He's sleek, modern and has a specific, headstrong appearance. The Sublimo is available in two sizes, the square **200x200 cm** and the **round 300 cm** version. These parasols are equipped with a perfect fitting gray protection cover.



EXTRA ATMOSPHERE

The Solero Accento click-on light fits around the mast of the Sublimo, it's a nice addition that gives the parasol just a little bit more appeal. When you point the lamp downwards you can easily read a book under it, but when you turn the Accento click-on light around you'll create indirect mood lighting, which is ideal to make the summer nights last a little longer.

UNIQUE PUSH-UP SYSTEM

Using the unique push-up system, the Sublimo is opened in two seconds, after which you find yourself relaxing in the shade below the fade resistant square cloth measuring 200 x 200 cm ϕ 300 cm. Through the integrated rib springs the canvas always remains tight, on top of that the canvas is watertight and colorfast, we even warranty the colorfastness for 4 years!

ANODISED FINISH

Every metal part of the Sublimo is anodized. With a special treatment, the metal is equipped with a slightly glossy layer that looks great and protects against corrosion and tear and wear.

2x2 METER

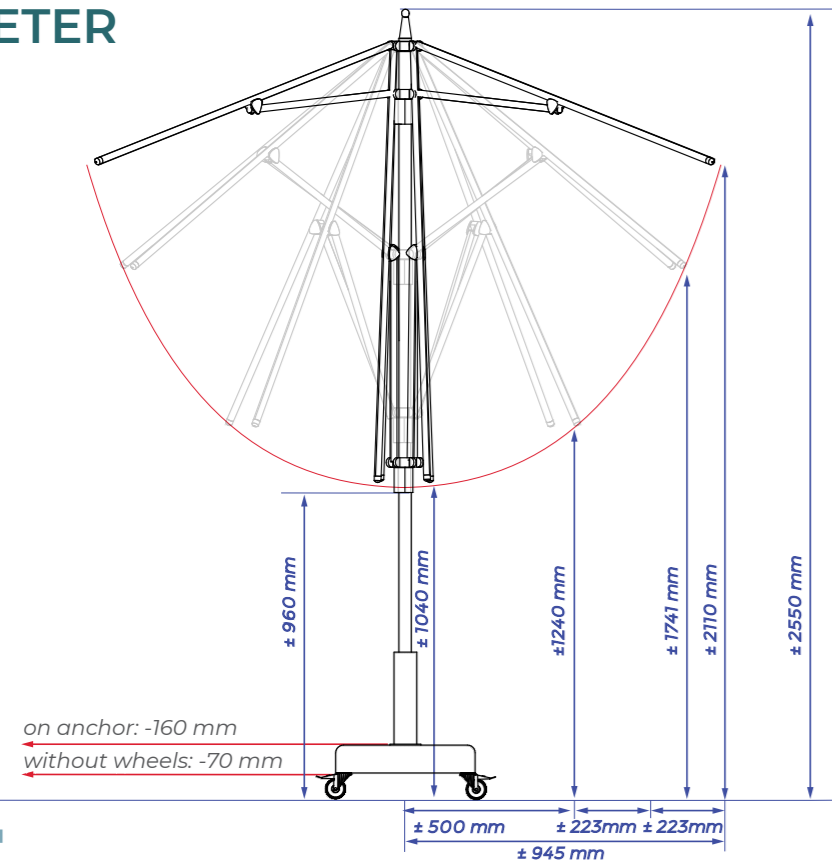

CHOOSE FROM 7 CLOTH COLOURS

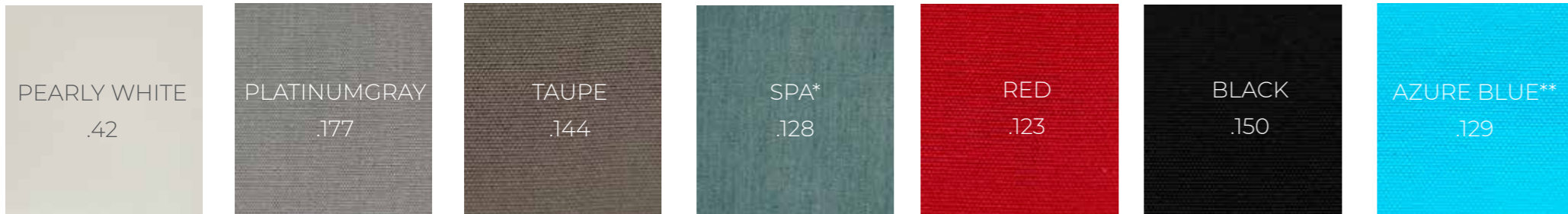

**This colour is produced as a limited edition and is only available for the 200x200 version of Sublimo Pro

Ø3 METER

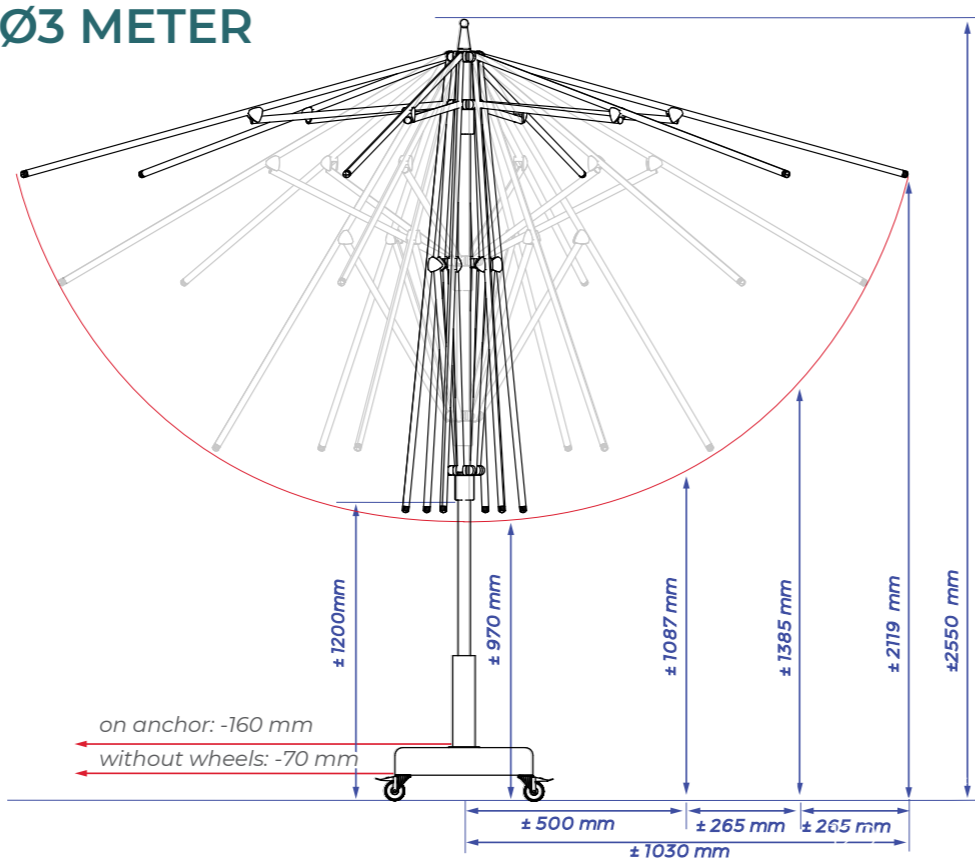

SPECIFICATIONS & PRICES



DELIVERY FROM STOCK*

VIDEO

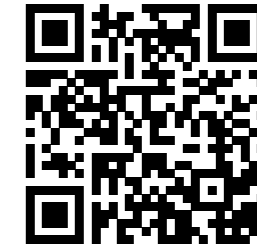

Item number	Description	Price in £ excl. VAT
820.20.colour	Sublimo 200x200 cm	329,-
820.30.colour	Sublimo Ø 300 cm	379,-
527.40.99	Fillable base Sublimo	79,-
527.35.55	Stainless steel groundanchor Sublimo	99,-
535.30.35	Concrete base 35 kg	169,-
535.31.60	4x wheels for Concrete base 35 kg	62,50,-
535.30.45	Concrete base 45 kg	199,-
535.55.00	Granite base 55 kg	299,-
535.30.10	Steel grass spike	109,-
535.24.54	Accento click-on light	119,-

Lighting and heating can be found on pages 68-73
Images of feet and anchors can be found on pages 82-83

Specifications	
Free protectioncover	yes
Cantilever sunshade	no
Central pole	yes
Telescopic system	no
Light included	no
Fade-resistant cloth	yes
Pole in two parts	no
Tiltable	no
With rotating device 360°	no
Side inclination up to 45°	no
Valance	no
Operating system	push-up
Weight cloth per m ²	210 grams
Integrated rib ends	yes
Number of ribs	4 / 6
Closes over the table	yes
Pole diameter	38 mm
Possibility of logo printing	yes

*While stocks last



SOLERO® VATICANO PRO

The Solero Vaticano with a **250 cm diameter** is a unique combination of a refreshing yet classic design. This parasol only takes little space, while its wide span and swiveling cloth offer plenty of shade. The Vaticano is an excellent add-on to virtually every decor style of your garden, balcony or terrace.

The fade resistant O'Bravia cloth, guarantees years of pleasure from this stylish trendsetter. The Vaticano looks classy and cheerful, the system operates handy and smoothly. The 24 flexible ribs ensure that the fade resistant cloth is always tensioned. Simply tilt the parasol to 45° to enjoy the shade, even when it's hanging low in autumn, exactly how you want it. Named after the dome in Vatican City, this parasol also does not take much room, while leaving a formidable impression with your guests.



STRONG AS IRON BUT LIGHT AS A FEATHER

It's rare for a parasol with a 250 cm. span width to be handled so lightly. The Vaticano is humble while being operated, but shows grandeur in its performance. And of course you'll receive a stylish gray protective cover with your order. The Solero Accento click-on light fits around the mast of the Vaticano, it's a nice addition that gives the parasol just a little bit more appeal.

BOTH FEET ON THE GROUND

The Vaticano can be securely fastened in several ways, for example, you can choose to go for a mobile, fillable pedestal, a ground anchor that can be settled in the ground while pouring concrete, or a granite pedestal of 60 kg with wheels. It's your choice to pick whichever option is easiest for your patio.

24 FLEXIBLE RIBS

The 24 ribs of the Vaticano keep the canvas nice and tight, even if the parasol is tipped, this way the setting sun can be blocked out without having to worry about a little wind.

Ø2.5 METER

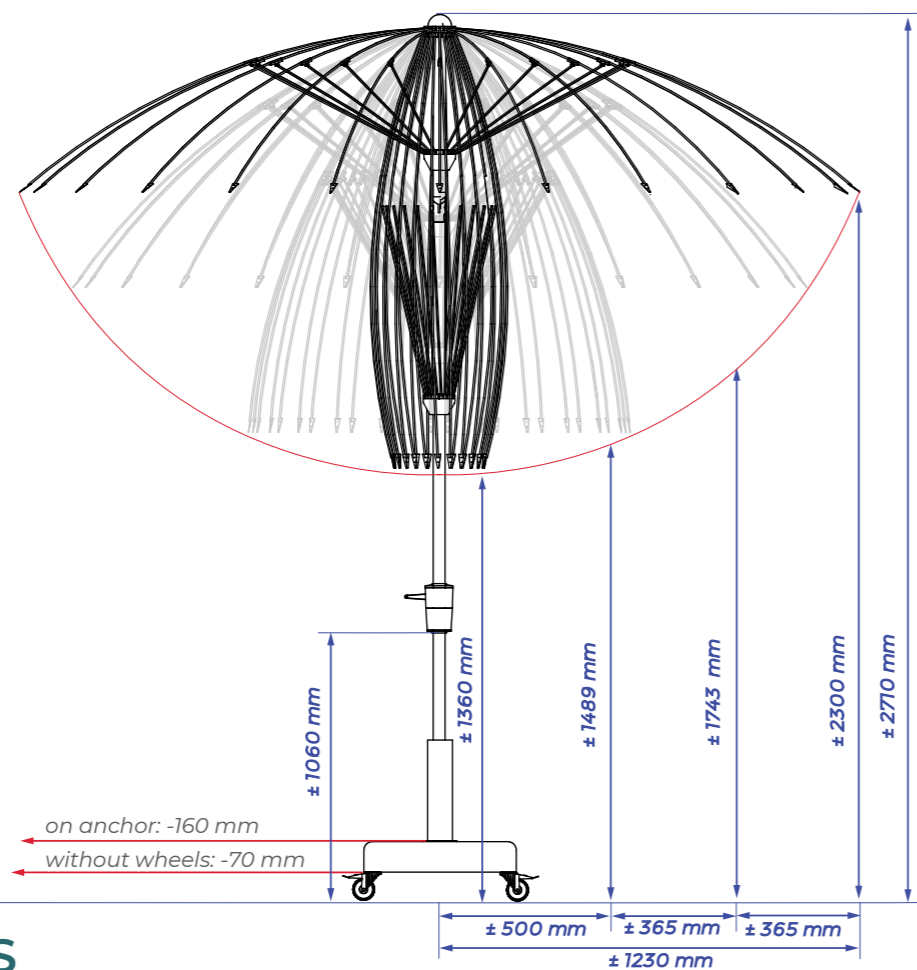

CHOOSE FROM 4 CLOTH COLOURS



SPECIFICATIONS & PRICES



DELIVERY FROM STOCK*

Item number	Description	Price in £ excl. VAT	Specifications
828.25.colour	Vaticano Ø 250 cm	269,-	Free protectioncover <input type="checkbox"/>
527.35.55	Ground anchor Vaticano	99,-	Cantilever sunshade <input type="checkbox"/>
535.30.35	Concrete base 35 kg	169,-	Central pole <input type="checkbox"/>
535.31.60	4x wheels for Concrete base 35 kg	62.50,-	Telescopic system <input type="checkbox"/>
535.30.45	Concrete base 45 kg	199,-	Light included <input type="checkbox"/>
535.55.00	Granite base 55 kg	299,-	Fade-resistant cloth <input type="checkbox"/>
535.30.10	Steel grass spike	109,-	Pole in two parts <input type="checkbox"/>
535.24.54	Accento click-on light	119,-	Tiltable <input type="checkbox"/>

Lighting and heating can be found on pages 68-73
 Images of feet and anchors can be found on pages 82-83

TIMELESS FRAME COLOR



VIDEO



With rotating device 360°	<input type="checkbox"/>
Side inclination	<input type="checkbox"/>
Valance (without add. costs)	<input type="checkbox"/>
Operating system	winch
Weight cloth per m ²	210 grams
Integrated rib ends	<input type="checkbox"/>
Number of ribs	24
Closes over the table	<input type="checkbox"/>
Pole diameter	38.5 mm

*While stocks last



SOLERO® TEATRO PRO

The Teatro parasol is the smallest member of the Solero family. This garden parasol has a cloth **diameter of 270cm**. The parasol cloth is made of a solid, heavy quality and is guaranteed to be fade resistant. The parasol cloth is made of a solid, heavy quality and is guaranteed to be fade resistant. After a number of years your blue parasol will be, well, still blue!

You can turn the Solero Teatro open and closed within a few seconds and the parasol is very easy to transport. So the Solero Teatro is also a welcome item at the campsite. But particularly in your garden, it will serve you well. Definitely with the Solero Accento click-on light.



“SHINE A LIGHT ON ME”

The Solero Accento click-on light fits around the mast of the Teatro, it's a nice addition that gives the parasol just a little bit more appeal. When you point the lamp downwards you can easily read a book under it, but when you turn the Accento click-on light around you'll create indirect mood lighting, which is ideal to make the summer nights last a little longer.

DYED BEFORE WEAVING

The canvas is made of a durable heavy quality and is guaranteed colorfast. Blue will remain deep blue, even after several years. Every fiber is colored individually before being weaved. On top of that, we'll provide you with a gray protective cover for your parasol, free of charge.



THE CHOICE IS YOURS

The Teatro can be securely fastened in several ways, for example, you can choose to go for a mobile, fillable pedestal, a ground anchor that can be settled in the ground while pouring concrete, or a granite pedestal of 60 kg with wheels. It's your choice to pick whichever option is easiest for your patio.



SOLERO® CIELO PRO

The Solero Cielo Pro **260x260 cm** just belongs at home in your garden. This heavy, cantilever parasol has a 260cm*260cm diameter. With its innovative control system you can open or collapse this quality parasol in a flash.

It's very easy to put this parasol into different skewing positions, without having to use the least bit of force. The firm base of the Cielo parasol is equipped with a clever turning mechanism. You can rotate this garden parasol easily and in 360 degrees by simply pressing the foot pedal. By releasing this pedal, this handy floating parasol will be automatically locked in its position.



EXTEND THE COSINESS

With the Cielo Pro comes the Solero Accento. This fantastic Solero Accento is provided with a charger. Using this, you can charge high quality batteries in a matter of hours. With the Cielo Pro parties can last longer, and it'll remain cozy for much longer.

PLENTY OF SHADE

The Cielo Pro by default is delivered with a set of free cross feet. Would you like to anchor the parasol on your patio? In that case you can order the special ground anchor.

BLACK STAYS BLACK

The canvas is made of a durable heavy quality and is guaranteed colorfast. Black will remain deep black, even after several years. Every fiber is colored individually before being weaved. On top of that, we'll provide you with a gray protective cover for your parasol, free of charge.

2.6×2.6 METER

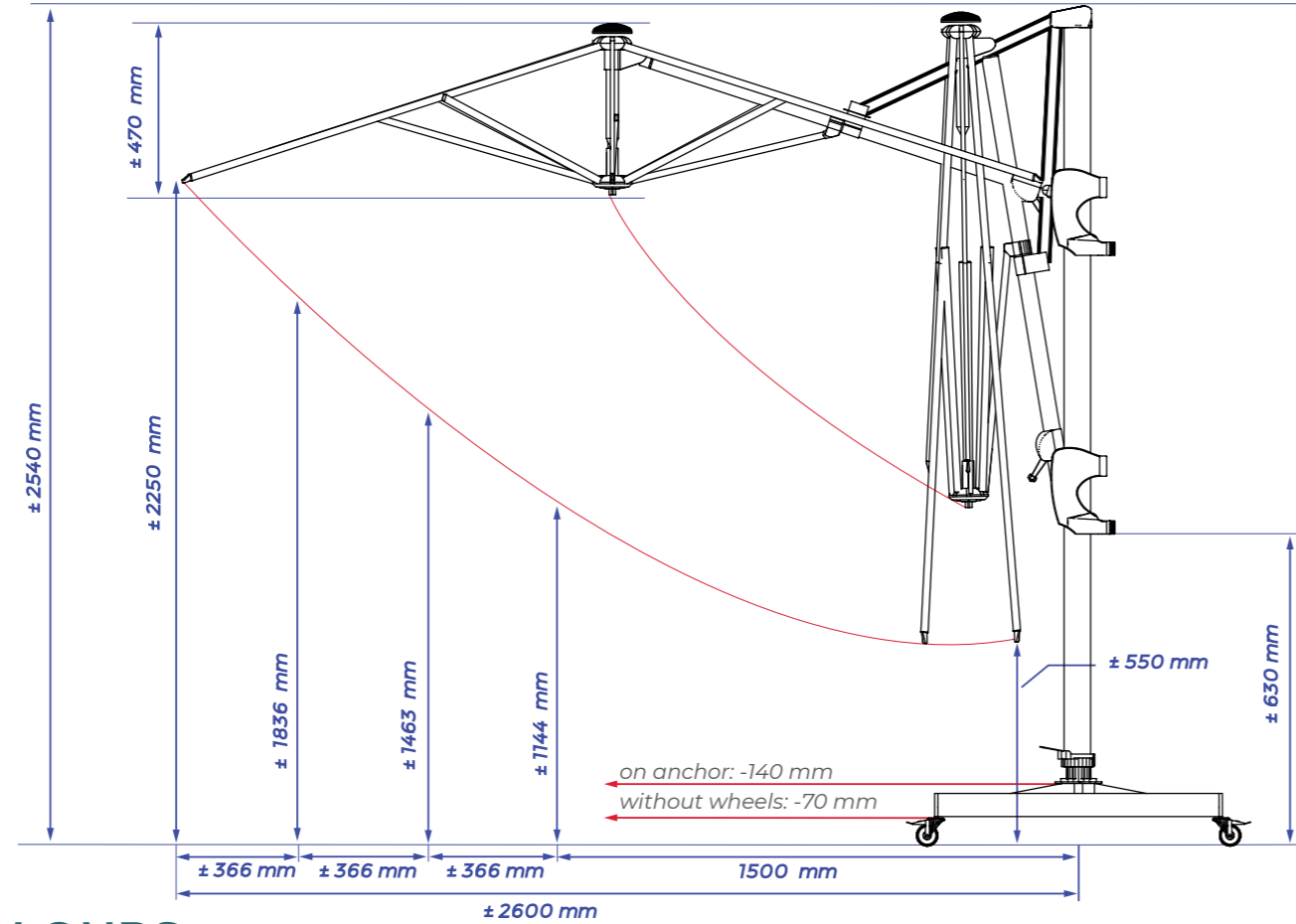

CHOOSE FROM 4 CLOTH COLOURS



SPECIFICATIONS & PRICES



DELIVERY FROM STOCK*

Item number	Description	Price in £ excl. VAT	Specifications
826.28.colour	Cielo Pro Sunshade	749,-	Free protectioncover yes
826.26.888	Cielo Pro Cross base	Free with purchase	Cantilever sunshade yes
832.33.99	Laterna Pro tile base + Cielo adaptation plate	249,-	Central pole no
835.50.994	Set of 4 castors 50 mm black	109,-	Telescopic system no
530.17.50	Cielo Pro Ground anchor	89,-	Light included yes
532.13.50	Dig-in base Cielo Pro	149,-	Fade-resistant cloth yes
535.24.54	Accento click-on light	Free with purchase	Pole in two parts no

Lighting and heating can be found on pages 68-73
 Images of feet and anchors can be found on pages 82-83

TIMELESS FRAME COLOR



VIDEO



Free protectioncover	yes
Cantilever sunshade	yes
Central pole	no
Telescopic system	no
Light included	yes
Fade-resistant cloth	yes
Pole in two parts	no
Tiltable	yes
With rotating device 360°	yes
Side inclination	no
Valance (without add. costs)	no
Operating system	Winch
Weight cloth per m²	300 grams
Integrated rib ends	no
Number of ribs	8
Closes over the table	no
Pole diameter	65 mm

*While stocks last



SOLERO® LATERNA PRO

Lounging, reading and relaxing on your terrace? Or enjoying those nice summer days with friends and family? The Laterna will bring your holiday to your own garden.

By using exclusively high quality materials we promise you'll enjoy your luxurious floating parasol for years to come. Due to its generous sizes (**300x300 cm or Ø 350 cm**) this parasol turns any outdoor area into a welcoming space for large and small groups. Despite its size, it's easy to handle and can be moved into any position with the one smooth move. Would you prefer not to have an unsightly pedestal or heavy tiles on your patio? This parasol can be anchored into the ground quickly and aesthetically.

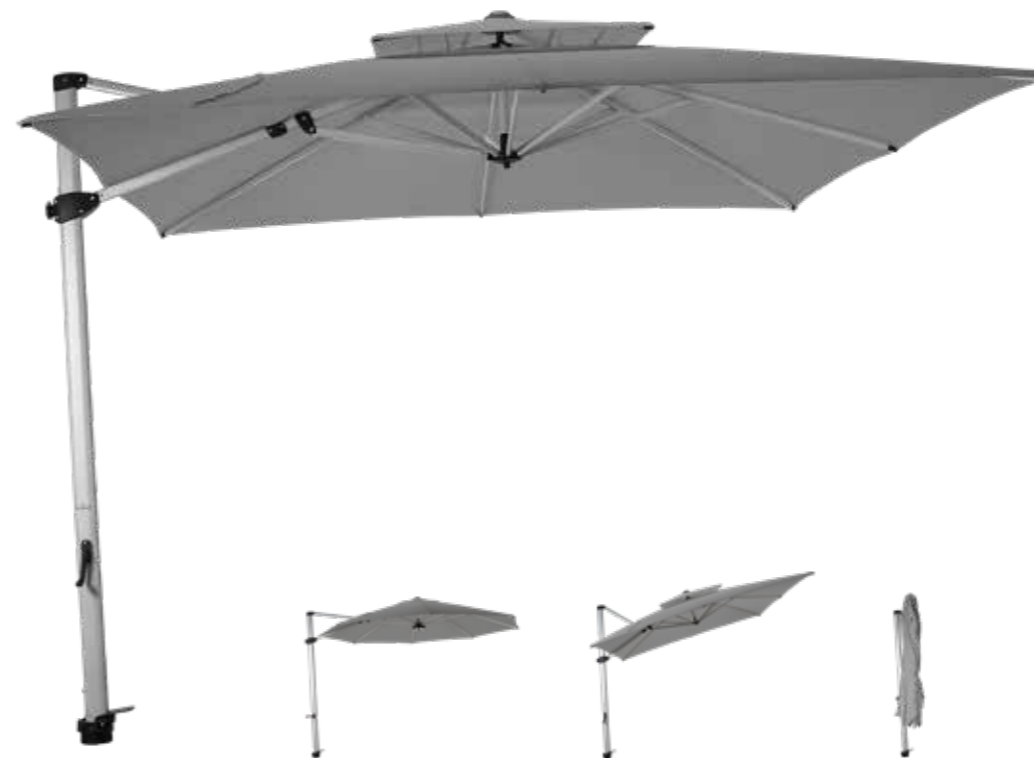

ALWAYS UNDER TENSION

The Laterna is delivered with a silver frame and comes with a complimentary protective cover. You'll also receive a wireless, rechargeable free lighting! The Laterna parasol cloth is kept tight in a beautiful way by its integrated rib ends.

FOLLOW YOUR INTUITION

With this luxurious floating parasol you'll get the maximum ease of use in your garden. The parasol has an intuitive control rod that allows effortless opening, closing and tilting. You can also rotate the parasol 360 degrees.



WIND VENTILATION ROOF

You'll always stay cool under the Solero Laterna. The square version is outfitted with a special wind ventilation roof. The round version has a wind catcher as well, but this isn't lifted up as high from an esthetical point of view. On (too) hot days the canvas also releases heat instead of capturing it under the parasol. On top of that, this helps the parasol gain stability. When wind flows under the parasol it'll easily be released.

3x3 METER

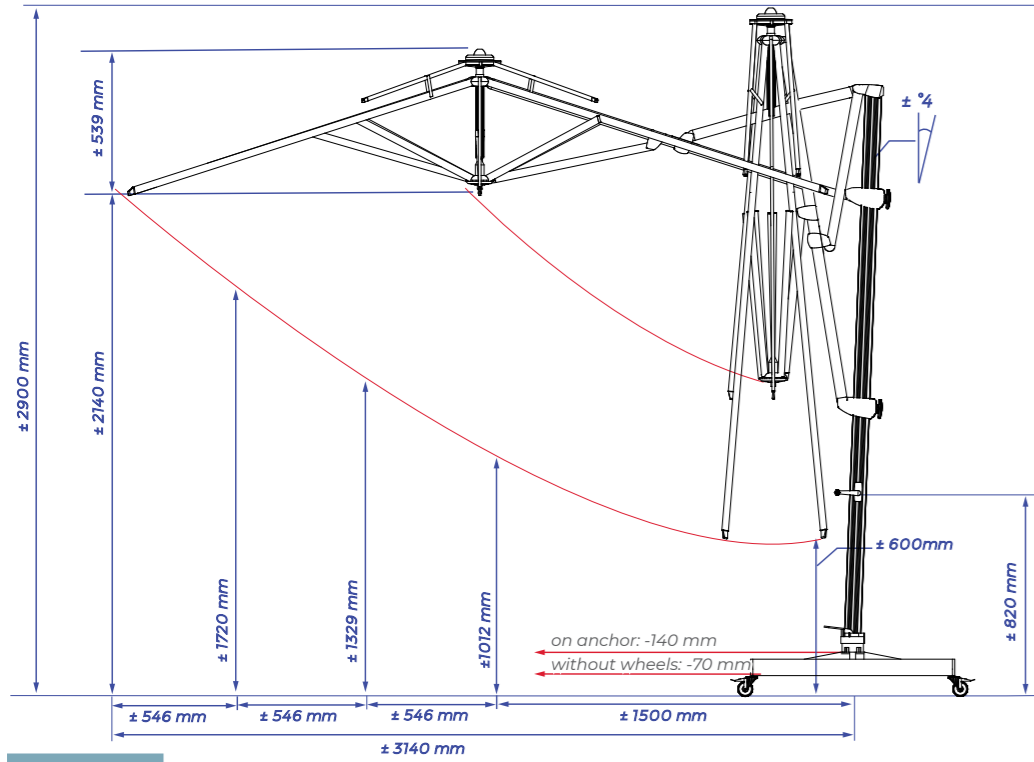

Ø3.5 METER

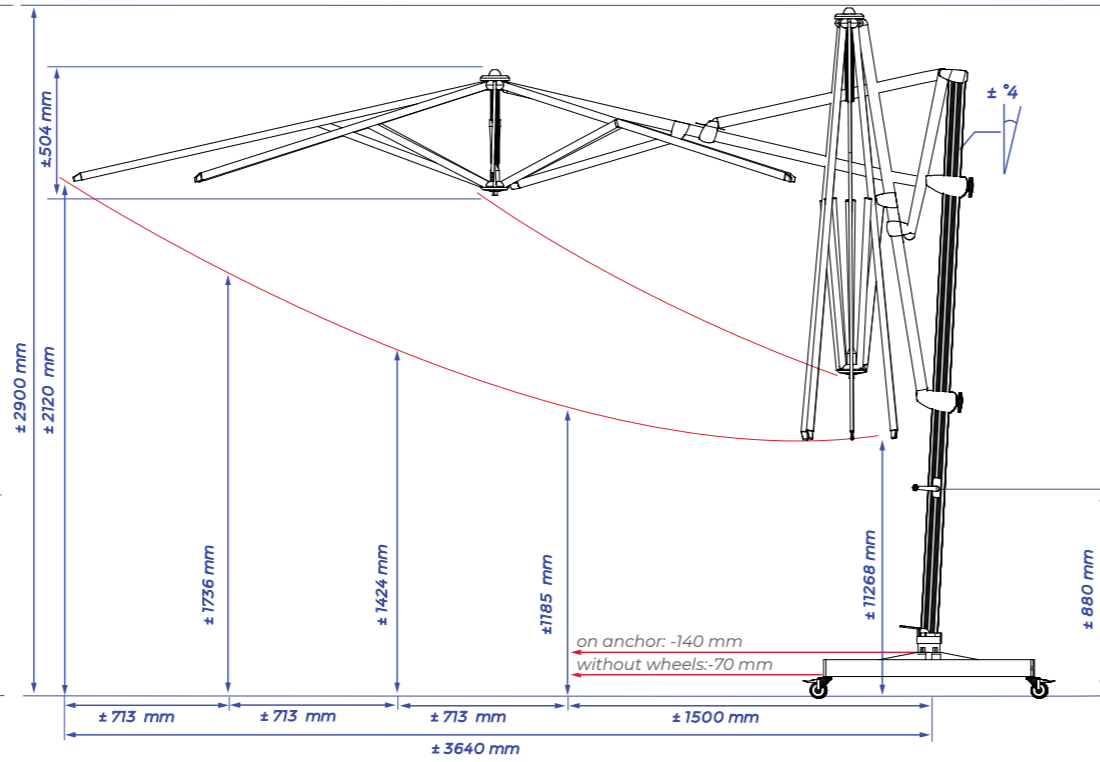

CHOOSE FROM 4 CLOTH COLOURS



SPECIFICATIONS & PRICES



DELIVERY FROM STOCK*

Item number	Description	Price in £ excl. VAT
832.33.colour	Laterna 300x300 cm	999,-
832.35.colour	Laterna Ø 350 cm	999,-
832.33.99	Tile base Laterna	249,-
532.34.99	Ground anchor Laterna	99,-
532.14.50	Dig-in base Laterna + adaption	187.50,-
835.50.994	Set of 4 castors 50 mm black	109,-
535.24.54	Accento click-on light	Free with purchase
532.15.50	Adaption Laterna	48.50,-

Lighting and heating can be found on pages 68-73
Images of feet and anchors can be found on pages 82-83

TIMELESS FRAME COLOR



VIDEO



Specifications	
Free protectioncover	yes
Cantilever sunshade	yes
Central pole	no
Telescopic system	no
Light included	yes
Fade-resistant cloth	yes
Pole in two parts	no
Tiltable	yes
With rotating device 360°	yes
Side inclination	no
Valance (without add. costs)	no
Operating system	Winch
Weight cloth per m²	300 grams
Integrated rib ends	yes
Number of ribs	8
Closes over the table	no
Pole diameter	80 mm

*While stocks last



SOLERO® FRATELLO PRO

A magnificent Italian design with remarkable functionality. Able to turn a full 360° around its outer axis and tilt 45° both sideways as backwards, the Fratello offers endless possibilities to utilize your exterior to the max.

As the big brother of our successful Laterna parasol, the Fratello (Italian for 'brother') gains respect by its endless possibilities. It follows the sun by tilting to every side and comes with a stylish silver gray frame. With its **300 x 300 cm.** size, you know that all your guests will rest assured under this strong arm with its perky character. The special Solero O'Bravia parasol canvas is made of durable, heavy quality and is also colorfast.



DISTINCTIVELY SUBTLE

The free hanging design of the Fratello, ensures that this large parasol works quite discretely for you. Enjoy the shade and cover, while the mast is hardly visible yet stylishly present. And of course the integrated winch is operated elegantly.

SHADE YOU CAN AIM

With the Solero Fratello you'll have different fastening options: a tile pedestal, ground anchor or borrowing pedestal. You can also secure the parasol to an existing concrete floor with an adaptor plate. The tile pedestal can be expanded with swiveling wheels allowing you to easily move it around.



CORDLESS CONVENIENCE

With the Fratello comes the Solero Accento. This fantastic Solero Accento is provided with a charger. Using this, you can charge high quality batteries in a matter of hours. With the Fratello parties can last longer, and it'll remain cozy for much longer.

3x3 METER

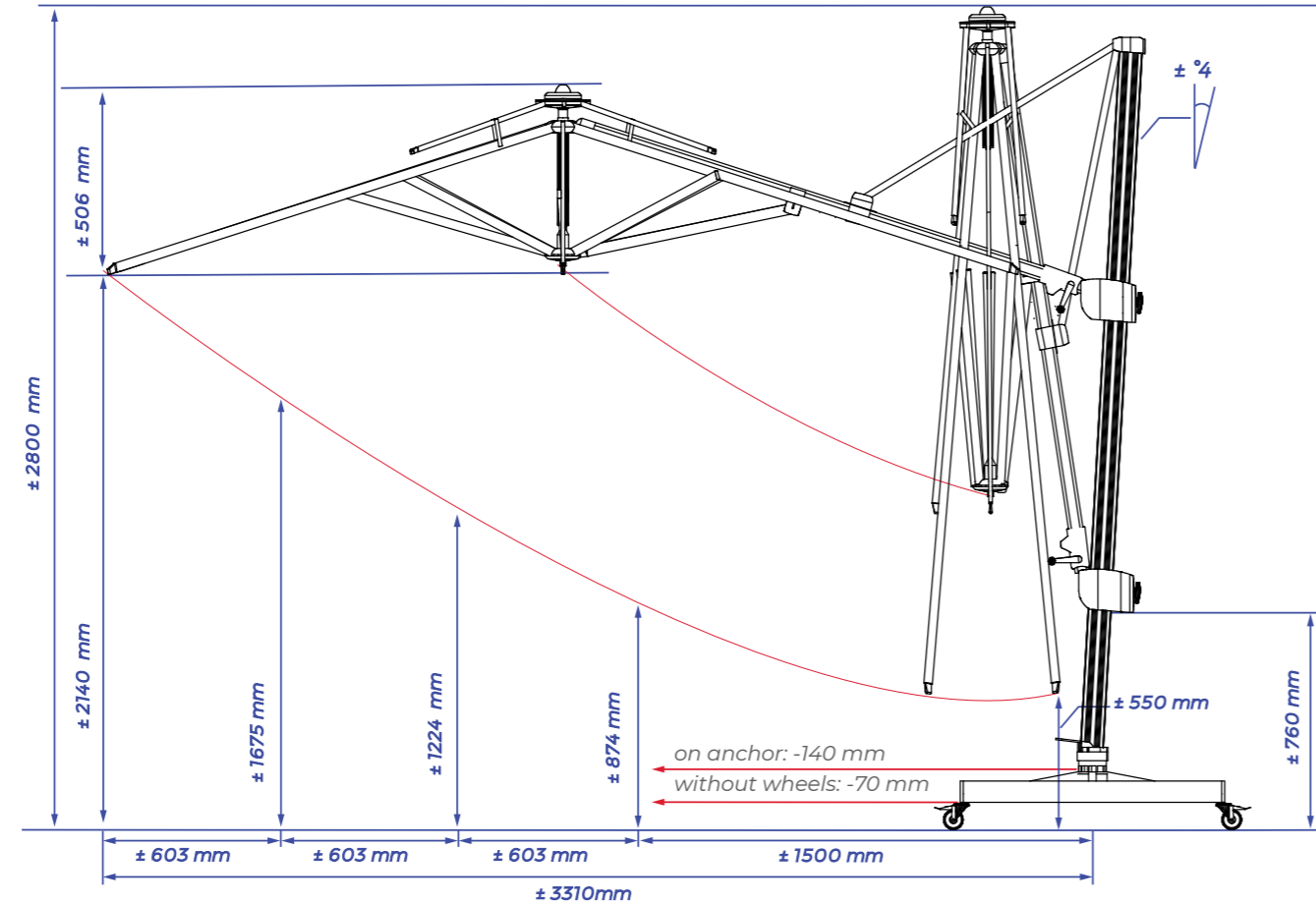

CHOOSE FROM 4 CLOTH COLOURS



SPECIFICATIONS & PRICES



DELIVERY FROM STOCK*

Item number	Description	Price in £ excl. VAT	Specifications
832.84.colour	Fratello 300x300 cm	1099,-	Free protectioncover yes
832.33.99	Tile base	249,-	Cantilever sunshade yes
532.34.99	Ground anchor	99,-	Central pole no
532.14.50	Dig-in base Fratello + adaption	145,-	Telescopic system no
835.50.994	Set of 4 castors 50 mm black	109,-	Light included yes
535.24.54	Accento click-on light	Free with purchase	Fade-resistant cloth yes
532.15.50	Adaption Fratello	48.50,-	Pole in two parts no

Lighting and heating can be found on pages 68-73
Images of feet and anchors can be found on pages 82-83

TIMELESS FRAME COLOR



VIDEO

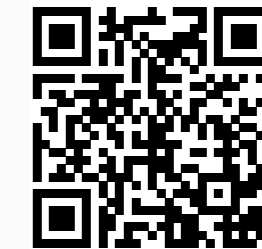

Free protectioncover	yes
Cantilever sunshade	yes
Central pole	no
Telescopic system	no
Light included	yes
Fade-resistant cloth	yes
Pole in two parts	no
Tiltable	yes
With rotating device 360°	yes
Side inclination up to 45°	yes
Valance (without add. costs)	no
Operating system	Winch
Weight cloth per m²	300 grams
Integrated rib ends	yes
Number of ribs	8
Closes over the table	no
Pole diameter	80 mm

*While stocks last



SOLERO® FUERTO PRO

Solero's Fuerto represents strength and elegance. This suspended parasol is a heavy duty model. The stable Fuerto Pro is available in **300x300 cm** which allows it to easily be used in the hospitality industry, but also makes it suitable for placement in the garden.

Fuerto is simple and fast to operate, indispensable features on your overflowing terrace this summer. Solero's latest addition is unique due to its push-and-pull system, which allows you to open the parasol with a simple pull. Closing it is just as easy, by pulling the handle of the parasol down. This professional parasol is not tiltable or rotatable, but provides a stable roof for your terrace.



THE SUSPENDED PARASOL

The suspended parasol that is extremely suitable for intensive use in the hospitality sector. The strong arm easily holds the 9 m² cloth in place and protects you and your guests against the warm summer sun and a summer shower.

NO CORD

Opening and closing a parasol that resembles the Fuerto is often done with a winch. But not with this powerhouse; the system opens and closes by means of a gas spring, so turning a winch is a thing of the past. This way, you have more time to enjoy the wonderful weather.

FOUR-YEAR COLOUR WARRANTY

The O'Bravia cloth is waterproof, colourfast and UV-resistant, and comes standard with a four-year colour warranty.

3x3 METER

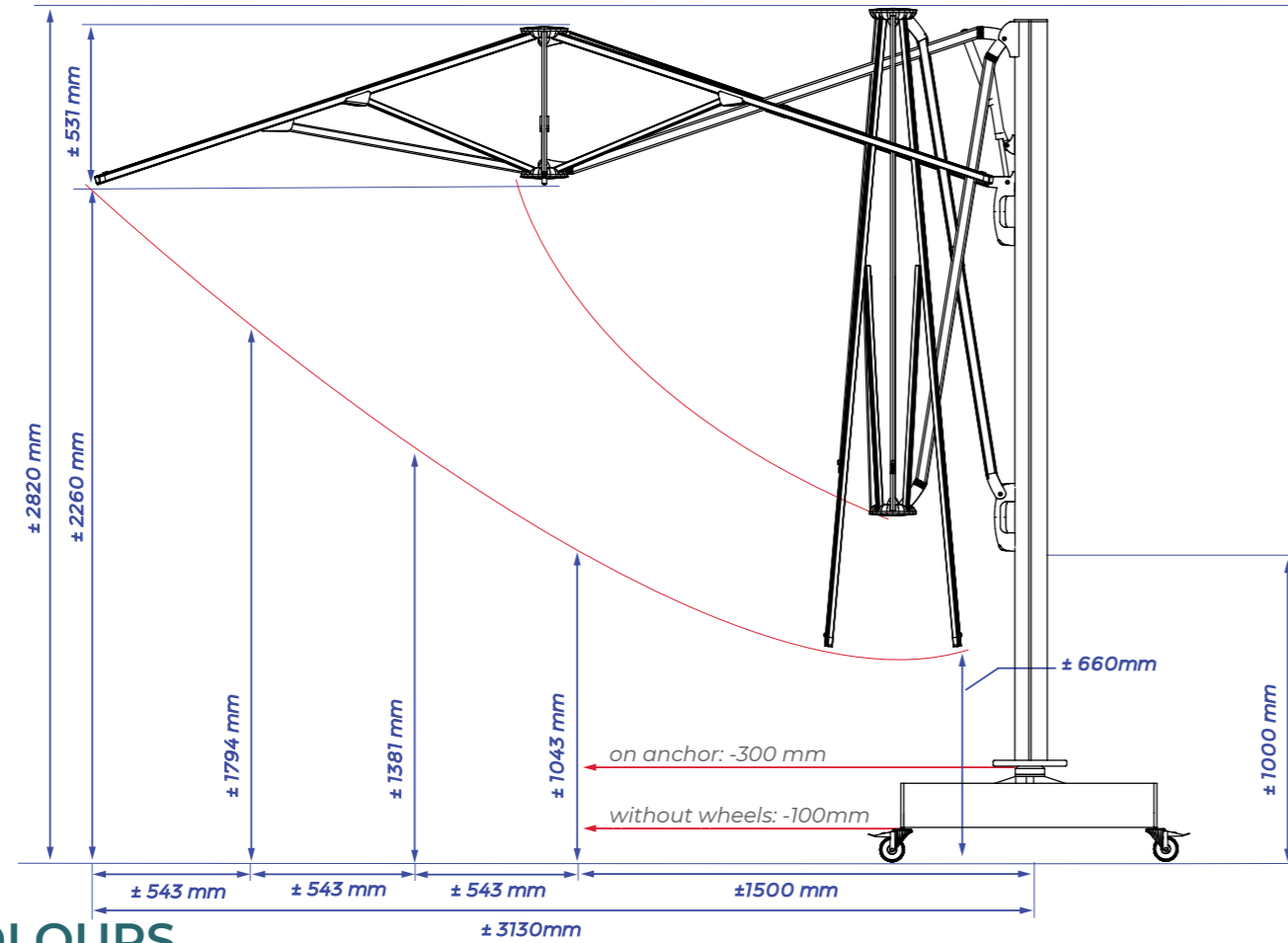

CHOOSE FROM 5 CLOTH COLOURS

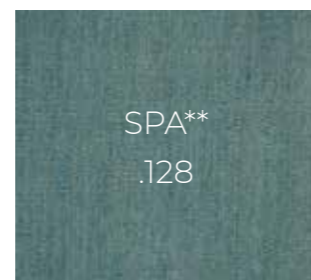

SPECIFICATIONS & PRICES



DELIVERY FROM STOCK*

Item number	Description	Price in £ excl. VAT	Specifications
860.33.colour	Solero Fuerto 300x300 cm sunshade	1649.-	Free protectioncover yes
842.84.99	Tile base Fuerto	419.-	Cantilever sunshade yes
542.85.99	Ground anchor Fuerto	145.-	Central pole no
835.50.994	Set of 4 castors 50 mm black	109.-	Telescopic system no

Lighting and heating can be found on pages 68-73
 Images of feet and anchors can be found on pages 82-83

Light included	no
Fade-resistant cloth	yes
Pole in two parts	no
Tiltable	no
With rotating device 360°	yes
Side inclination	no
Valance (without add. costs)	no
Operating system	push & pull
Weight cloth per m ²	300 grams
Integrated rib ends	yes
Number of ribs	8
Closes over the table	no
Pole diameter	app. 110mm

TIMELESS FRAME COLOR



VIDEO



*While stocks last



SOLERO® PATIO PRO

Are you looking for a great quality design parasol for an affordable price? The Solero Patio parasol **300x300 cm** is the best choice around, showing that a sleek design can be very attractive.

This design parasol has a solid frame with a powder coated pole that has a 50mm diameter. Of course you can choose from a wide range of trendy fade-resistant cloth colors.



A WELCOME GUEST

This square parasol is handled just as easy as our other models. The Patio forms a perfect protection from the sun for the hospitality industry. No doubt about it, this is a true eye-catcher, especially when combined with the Solero Accento clickon lighting.

COLOURFAST O'BRAVIA CLOTH

The special Solero O'Bravia parasol canvas is made of durable, heavy quality and is also colorfast. Blue remains a deep blue and doesn't fade after two seasons. The parasol canvas keeps its tension through the tensioners in the ribs. The Patio is delivered with a free protective cover and can be placed with a pedestal or a ground anchor.

HOIST THE SAILS

A classic, this Patio. This shade maker opens and closes by means of sturdy cord and two high-quality pulleys, as you are used to from a parasol. You can store the cord on the designated hook on the mast. Simple as that.

3x3 METER

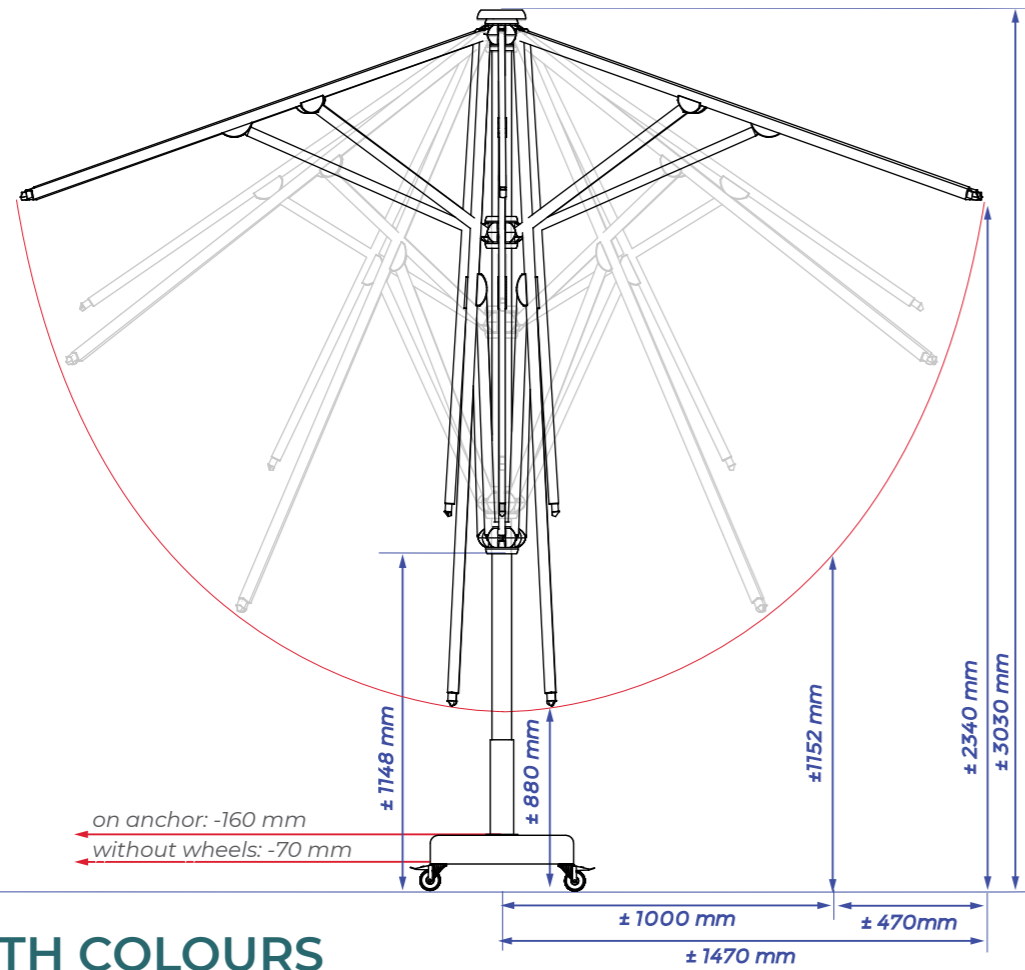

CHOOSE FROM 6 CLOTH COLOURS



SPECIFICATIONS & PRICES



DELIVERY FROM STOCK*

Item number	Description	Price in £ excl. VAT	Specifications
834.33.colour	Patio 300x300 cm	599,-	Free protectioncover <input type="checkbox"/> yes
535.28.50	Fillable base Patio black 70-100 kg	109,-	Cantilever sunshade <input type="checkbox"/> no
535.28.62	Fillable base Patio gray 70-100 kg	109,-	Central pole <input type="checkbox"/> yes
527.51.55	Ground anchor Patio	119,-	Telescopic system <input type="checkbox"/> no
535.55.00	Granite base 55 kg	299,-	Light included <input type="checkbox"/> no
535.30.60	Concrete base 60 kg	249,-	Fade-resistant cloth <input type="checkbox"/> yes
535.31.60	4x wiel Concrete base 60 kg	70,-	Pole in two parts <input type="checkbox"/> no
535.24.54	Accento click-on light	119,-	Tiltable <input type="checkbox"/> no

Lighting and heating can be found on pages 68-73
 Images of feet and anchors can be found on pages 82-83

TIMELESS FRAME COLOR



VIDEO

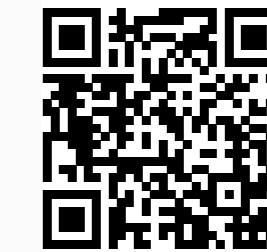

With rotating device 360°	<input type="checkbox"/> no
Side inclination	<input type="checkbox"/> no
Valance (without add. costs)	<input type="checkbox"/> no
Operating system	cord
Weight cloth per m²	300 grams
Integrated rib ends	<input type="checkbox"/> yes
Number of ribs	8
Closes over the table	<input type="checkbox"/> no
Pole diameter	51 mm

*While stocks last



SOLERO® LASAGNA PRO

Made up of layers, this parasol owes its name to the delicious Italian oven dish. Not only does this look good, but these layers have two special functions as well. Because there is room between the so-called multiValances, the air can easily pass through the openings. This means the Lasagna Pro stands firm, even in winds. In addition, you keep your head cool. Warm air that collects under the parasol rises up and disappears.

This breath-taking layer parasol has a diameter of **Ø330 cm** and is easy to operate. The cloth is always nice and tight thanks to the metal tensioners.



BREATHE IN, BREATHE OUT

Have you ever walked in heavy rains with an umbrella? Then you know how the wind can tug at the inside of your umbrella. If that air had a way to escape, carrying your umbrella would be much lighter. Right? The Lasagna Pro takes this into account. The parasol stays waterproof because the layers overlap.

CUT FROM THE RIGHT WOOD

Aluminium may be light, strong, recyclable and pretty, it still feels different than hout. Wood is a natural product and creates a warm appearance. With a relatively low weight, it has great strength and is characteristic. A wooden parasol is a natural connection between your indoor and outdoor areas.



RUNS SMOOTHLY

Just like Solero's Patio parasol, the Lasagna Pro opens by means of a strong cord and a double pulley. Hoist the sails and enjoy your shade.

Ø3.3 METER

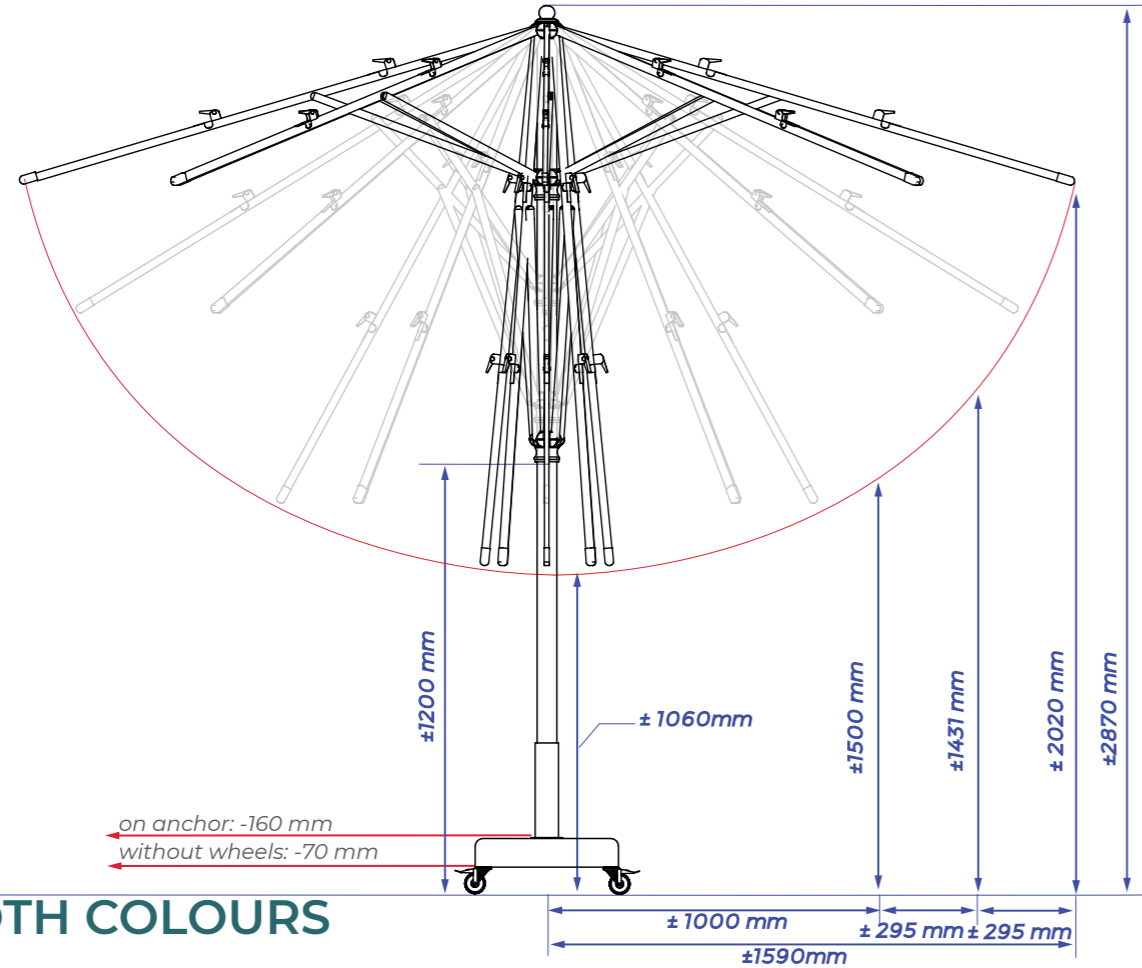

CHOOSE FROM 4 CLOTH COLOURS

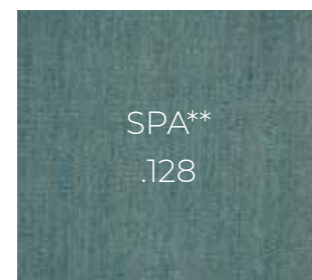

**This colour will be produced in limited numbers

SPECIFICATIONS & PRICES



DELIVERY FROM STOCK*

Item number	Description	Price in £ excl. VAT	Specifications
838.33.colour	Lasagna Pro Ø330 cm sunshade	699,-	Free protectioncover yes
535.28.50	Fillable base black 70-100 kg	109,-	Cantilever sunshade no
535.28.62	Fillable base gray 70-100 kg	109,-	Central pole yes
527.51.55	Ground anchor	119,-	Telescopic system no
535.55.00	Granite base 55 kg	299,-	Light included no
535.30.60	Concrete base 60 kg	249,-	Fade-resistant cloth yes
535.31.60	4x wiel Concrete base 60 kg	70,-	Pole in two parts no
535.24.54	Accento click-on light	119,-	Tiltable no

Lighting and heating can be found on pages 68-73
 Images of feet and anchors can be found on pages 82-83

TIMELESS FRAME COLOR

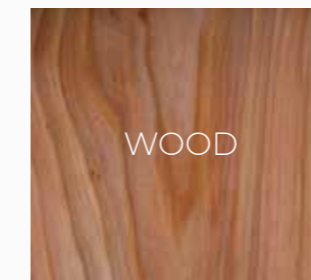

VIDEO



With rotating device 360°	no
Side inclination	no
Valance (without add. costs)	no
Operating system	cord
Weight cloth per m²	300 grams
Integrated rib ends	no
Number of ribs	8
Closes over the table	yes
Pole diameter	48mm

*While stocks last



SOLERO® PRESTO PRO

Presto Italian for 'quick', the newest edition to the Solero hospitality parasols lives up to its name. With the unique easy-turn system the Presto **330x330 cm or 400 cm round** is opened in a flash.

Collapsing it is even done almost fully automatic. As soon as you release the button, the Presto parasol instantly slides back into its closed position. An ideal solution for the hospitality industry, it truly helps you get home quickly after a long day of work! Using just two fingers you can open and close this parasol, ideal for hospitality where everybody needs to be able to open or close the parasol. We're definitely not forgetting about the users who have less strength in their hands, the Presto is definitely a good choice for this group of users as well.



CLOSE OVER TABLES AND CHAIRS

The biggest advantage of the Presto is the closing height, this is the distance from the ribs to the ground. The Presto has a telescopic frame that's often used in hospitality, allowing the parasol to essentially rise up the moment it's closed. This allows tables and chairs to remain under the parasol when it's closing.

CHILD'S PLAY

With the easyturn knob you'll really open the parasol in just 2 seconds. Closing it is almost automatic. As soon as you turn the knob back, the Presto parasol will slide into the closed position. The Solero Presto is delivered with a robust mast of 63mm with a chic silver gray finish.



ALWAYS A GREEN CHOICE

The special colorfast canvas of the Presto is, just like our other canvases, outfitted with a water repellent coating. The Presto parasol is also 100% recyclable. Good for the environment, and great protection for you. The canvas has a UPF value of 50+. Of course you'll receive a protective cover with your parasol to be able to store it safely on the moments you're not using it.

3.3x3.3 METER

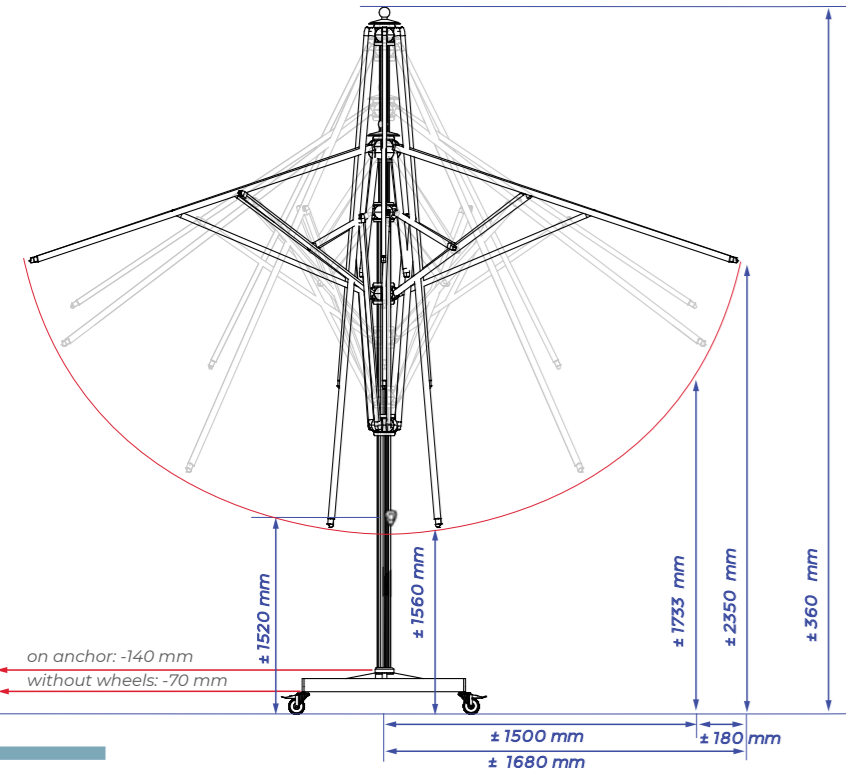

CHOOSE FROM 4 CLOTH COLOURS



Ø4 METER

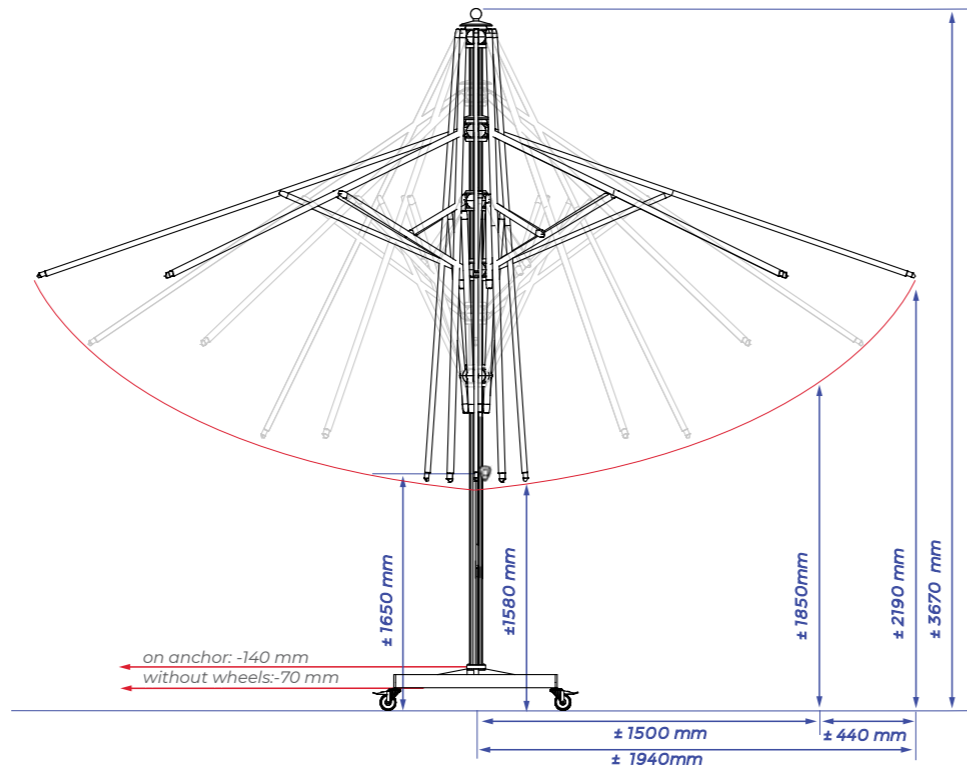

SPECIFICATIONS & PRICES



DELIVERY FROM STOCK*

Item number	Description	Price in £ excl. VAT	Specifications
833.33.colour	Presto 330x330 cm	849,-	Free protectioncover <input type="checkbox"/>
833.40.colour	Presto ø 400 cm	849,-	Cantilever sunshade <input type="checkbox"/>
833.51.70	Tile base Presto	249,-	Central pole <input type="checkbox"/>
835.75.994	Set of 4 castors 75 mm black	109,-	Telescopic system <input type="checkbox"/>
533.50.70	Ground anchor Presto	209,-	Light included <input type="checkbox"/>
535.30.90	Granite base 90 kg	499,-	Fade-resistant cloth <input type="checkbox"/>
535.31.90	4x wheels for granite base 90 kg	84,-	Pole in two parts <input type="checkbox"/>
			Tiltable <input type="checkbox"/>
			With rotating device 360° <input type="checkbox"/>
			Side inclination <input type="checkbox"/>
			Valance (without add. costs) <input type="checkbox"/>
			Operating system <input type="checkbox"/> easy turn
			Weight cloth per m ² <input type="checkbox"/> 300 grams
			Integrated rib ends <input type="checkbox"/> yes
			Number of ribs <input type="checkbox"/> 8
			Closes over the table <input type="checkbox"/> yes
			Pole diameter <input type="checkbox"/> 65 mm

Lighting and heating can be found on pages 68-73
 Images of feet and anchors can be found on pages 82-83

TIMELESS FRAME COLOR



VIDEO



*While stocks last



SOLERO® PALESTRO PRO

Eat, drink, talk, play, enjoy, that's what your garden is for. The Palestro improves these experiences. This floating parasol turns over your dining table and over the lawn for your children.

The Palestro turns above the terrace to linger in the evening. And of course its fully kids proof, as its securely mounted with its ground anchor. A modern design that still fits in every backyard. Robustly designed to be able to take a hit and with a colorfast canvas that'll last for years. It has a large size, a surface of 12 or 16 square meters, allows everyone to find their favorite spot in the shade.

Palestro is available in **300x400 cm and 400x400 cm**. take into account that the mast of the Palestro is on the largest side with the 300x400 cm version!

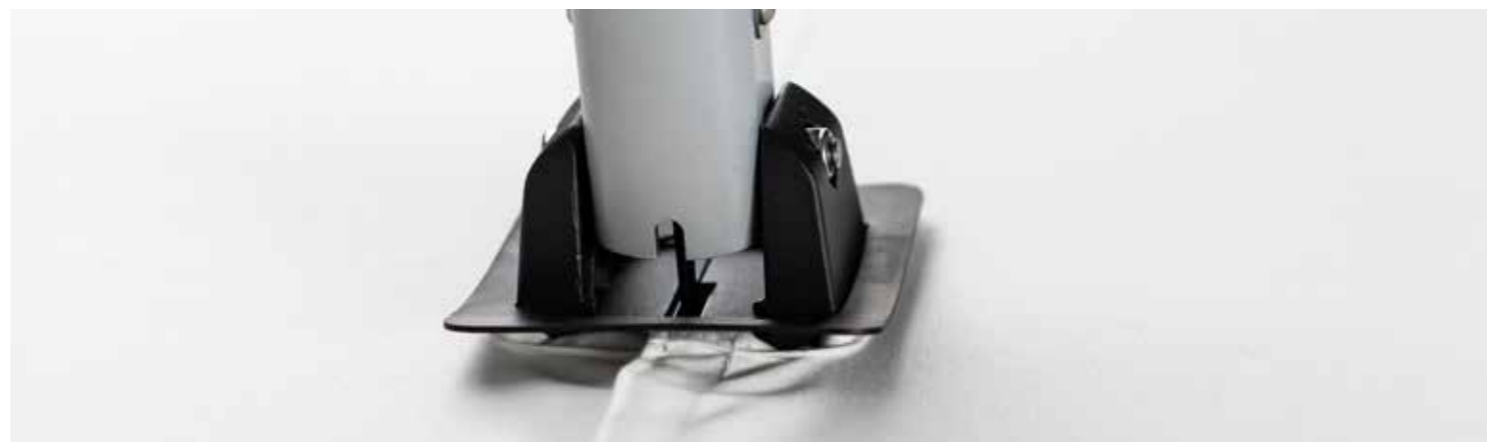

ROBUST DESIGN

A sleek design that fits in every garden. The large 400 x 400 cm or 300x400 cm cloth ensures that everybody finds its favorite place in the shadow. Its robust design ensures it can stand a rough handling and the fade resistant cloth that looks brand new for years. The Palestro is an add-on for the entire family, that quickly becomes a part of your outside.

FLEXIBLE AND COMPLIANT

The Palestro proves that being big and beautiful doesn't have to be hard. With the nifty rotating mechanism and supple winch you'll turn and tilt this parasol easily in any direction. That way you'll easily enjoy all of its qualities.

WITH ONE CLICK

The fantastic Solero Accento lighting is delivered with the Palestro and is provided with a charger. Using this, you can charge high quality batteries in a matter of hours. With the Palestro parties can last longer, and it'll remain cozy for the whole night.

4x4 METER

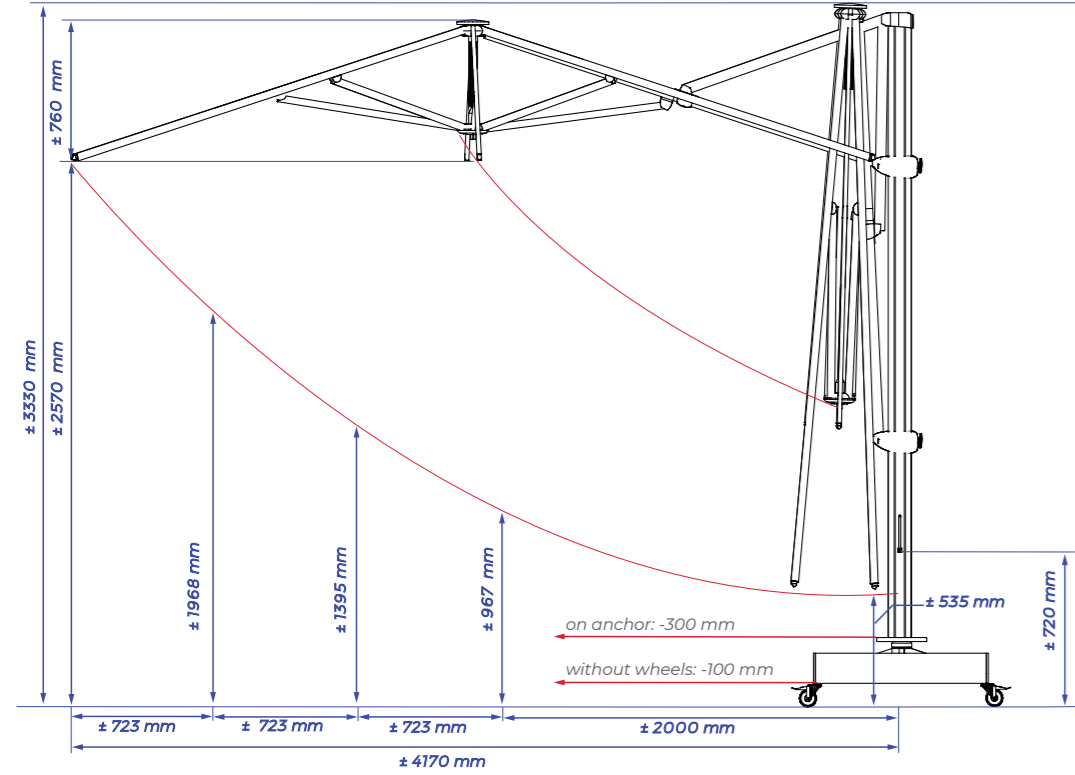

CHOOSE FROM 4 CLOTH COLOURS



4x3 METER

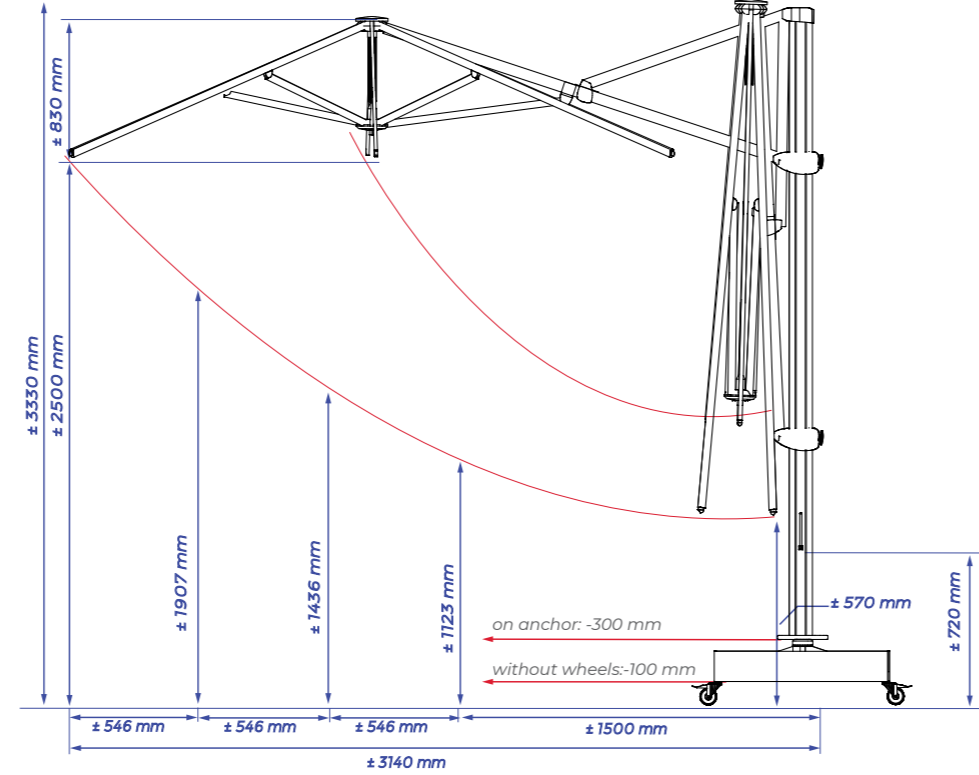

SPECIFICATIONS & PRICES



DELIVERY FROM STOCK*

Item number	Description	Price in £ excl. VAT
842.33.colour	Palestro 300x400 cm	2049,-
842.83.colour	Palestro 400x400 cm	2099,-
542.85.99	Ground anchor Palestro	280,-
842.84.99	Tile base Palestro	419,-
535.24.54	Accento click-on light	Free with purchase

Lighting and heating can be found on pages 68-73
Images of feet and anchors can be found on pages 82-83

Specifications	
Free protectioncover	yes
Cantilever sunshade	yes
Central pole	no
Telescopic system	no
Light included	yes
Fade-resistant cloth	yes
Pole in two parts	no
Tiltable	yes
With rotating device 360°	yes
Side inclination	no
Valance (without add. costs)	no
Operating system	winch
Weight cloth per m ²	300 grams
Integrated rib ends	yes
Number of ribs	8
Closes over the table	no
Pole diameter	115 mm

TIMELESS FRAME COLOR



VIDEO

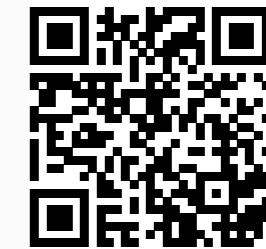

*While stocks last



SOLERO® MAESTRO PRO

Are you looking for a large square parasol for the hospitality industry? One with a fade resistant cloth and a solid appearance of **300x400 cm or 400x400 cm**? Preferably one with a great quality and a low pricing that is easy to handle? The Solero Maestro Pro parasol makes for a great offer for just that need!

The Maestro Pro forms a perfect protection from the sun for the hospitality industry. This square parasol has a very large surface, but is handled just as easy as our other models. A waiter or waitress will be able to open or close this parasol in a flash. The frame is made of aluminum and if necessary, you can attach gutters against the rain. That way you and your guests can enjoy your patio under the waterproof parasols.



PERFECT FOR HOSPITALITY

Many patios home and abroad are covered by the Maestro Pro. The special O'Bravia canvas is of a durable, heavy quality, colorfast and waterproof. The Maestro won't change colors after several seasons. The frame is made of aluminum and if necessary, you can attach gutters against the rain. That way you and your guests can enjoy your patio under the waterproof parasols.

YOUR LOGO ON THE EDGE

The Maestro parasol is equipped with a telescopic mast, this means that the mast lowers when it's opened and rises when it closes. A big advantage, especially for hospitality, is that furniture doesn't have to be moved, it can just stay in place. The Maestro Pro is perfect to get printed on as well; logo's and text will be legible and can be printed on in our shop, ask us for your options and pricing!

MASTERFUL OPERATION

The Maestro is so easy to use that everyone can do it. Because of that, the control rod can be removed so that you alone can open or close the parasol when necessary.

4x4 METER

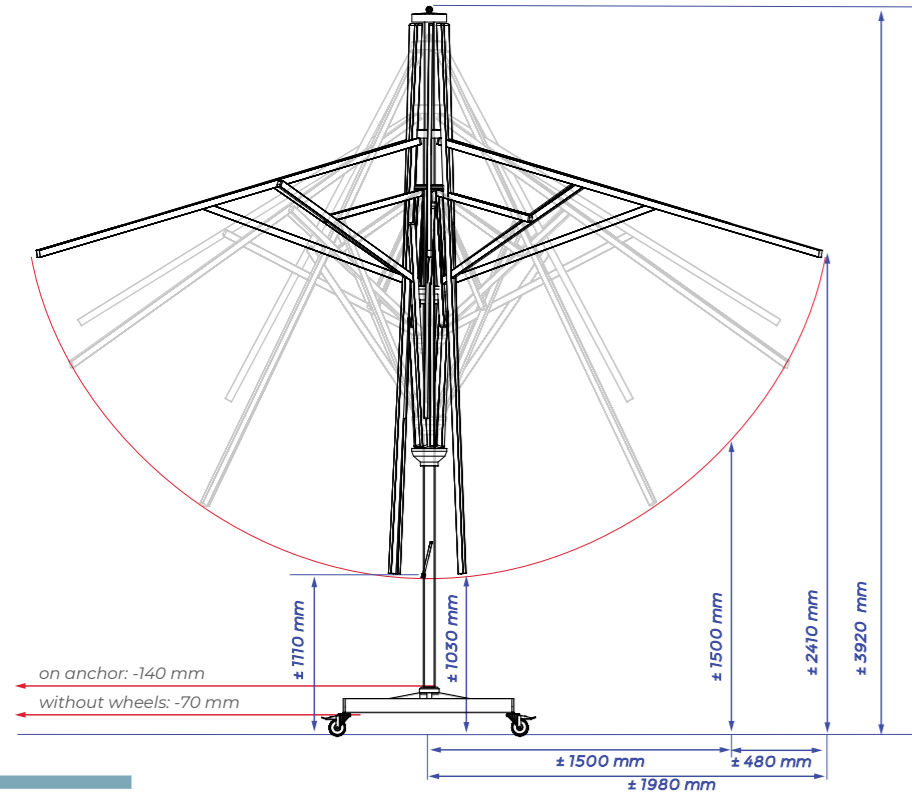

CHOOSE FROM 6 CLOTH COLOURS



**Only available in the 400x400cm size of Maestro Pro

4x3 METER

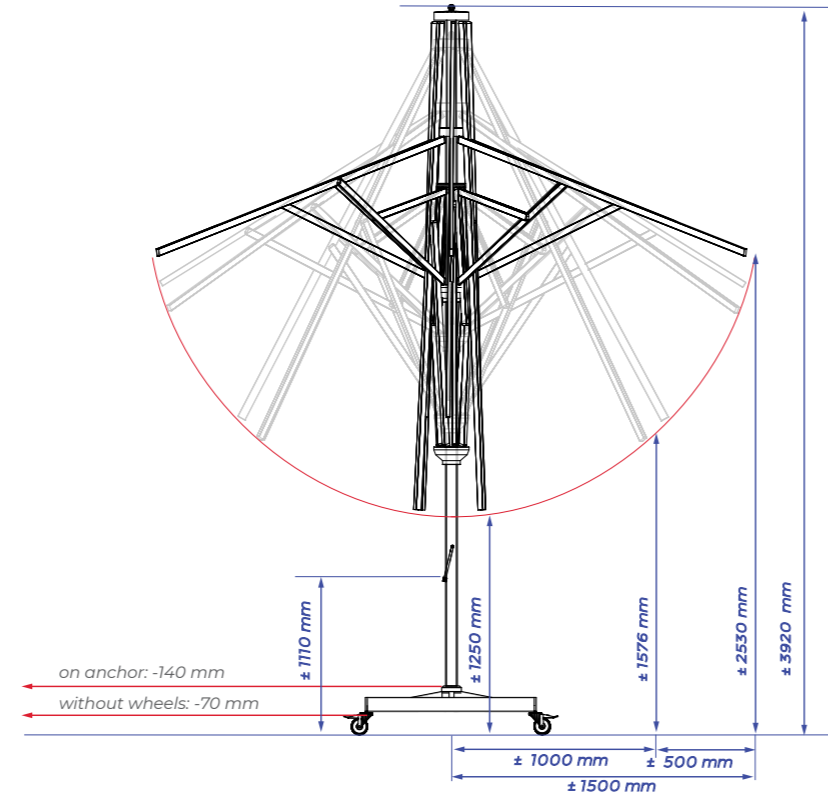

SPECIFICATIONS & PRICES



DELIVERY FROM STOCK*

Item number	Description	Price in £ excl. VAT
844.33.colour	Maestro 300x400 cm	1599,-
844.44.colour	Maestro 400x400 cm	1649,-
835.63.50	Maestro Tile base	299,-
850.44.50	Maestro Ground anchor	229,-
835.75.994	Set of 4 castors 75 mm black	109,-

Lighting and heating can be found on pages 68-72
Images of feet and anchors can be found on pages 82-83

Specifications	
Free protectioncover	yes
Cantilever sunshade	no
Central pole	yes
Telescopic system	yes
Light included	no
Fade-resistant cloth	yes
Pole in two parts	no
Tiltable °	no
With rotating device 360°	no
Side inclination	no
Valance (without add. costs)	standard
Operating system	winch
Weight cloth per m ²	300 grams
Integrated rib ends	no
Number of ribs	8
Closes over the table	yes
Pole diameter	81 mm

TIMELESS FRAME COLOR



VIDEO



*While stocks last



SOLERO® BASTO PRO

How does one look at your terrace from afar? The remarkable and robust appearance of the Basto radiates taste and quality. The unique character of this parasol, operated very smoothly with its detachable winch, adds a great deal of appeal.

A sleek design with straight lines, that also looks marvelous while looking upwards to its eight stylishly decorated ribs. And it's a big one, as the squarely designed Basto is available in the sizes **400x400 cm** and **500x500 cm**. The Basto is equipped with a telescopic mast, that means the mast slides down when being opened, and up when being closed. This allows the parasol to open and close above a table. A large advantage for hospitality entrepreneurs because tables and chairs don't have to be constantly moved when opening or closing the parasol. The frame of the Solero Basto is made out of high quality aluminum. It's relatively lightweight and is very strong, the material also lasts against corrosion and is recyclable.



CARE-FREE AND MAINTENANCE-FREE

The colorfast O'Bravia canvas with 300 gramss thickness is especially robust and guarantees years of worry- and maintenance free enjoyment. This large surface is easy to operate. Sometimes style and efficiency do go very well together. Even after several seasons the parasol will not discolor. The frame is made of a heavy aluminum construction and if you require it can have gutters attached to protect against the rain.

TAKE CONTROL

The control rod allows the operation of the winch, it applies pressure to the cables or relieves it. By why a removable control rod? Especially in hospitality it's a good idea to remove the control rod from the parasol so it can't easily be stolen, or have unauthorized people operate the parasol.



YOUR LOGO IN THE SUN

Would you like your company name or logo in the spotlight? That's possible. The canvas of the Basto hospitality parasol is perfect for printing on. When purchasing the Basto you'll receive a gray protective cover free of charge, which is equipped with a dirt- and water resistant coating and a modest logo.

5x5 METER

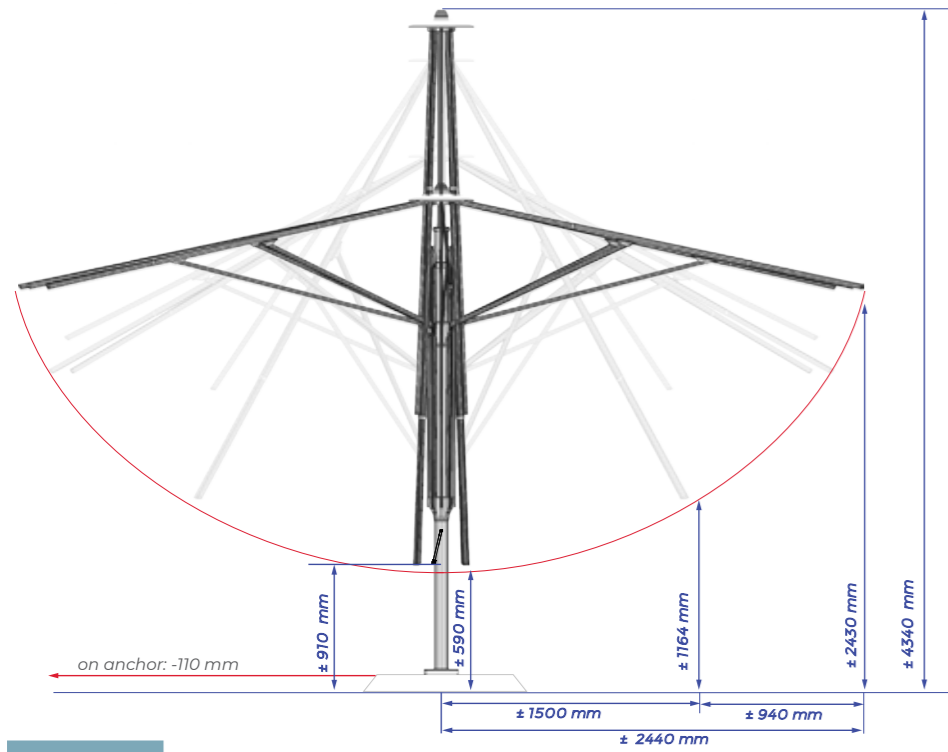

4x4 METER

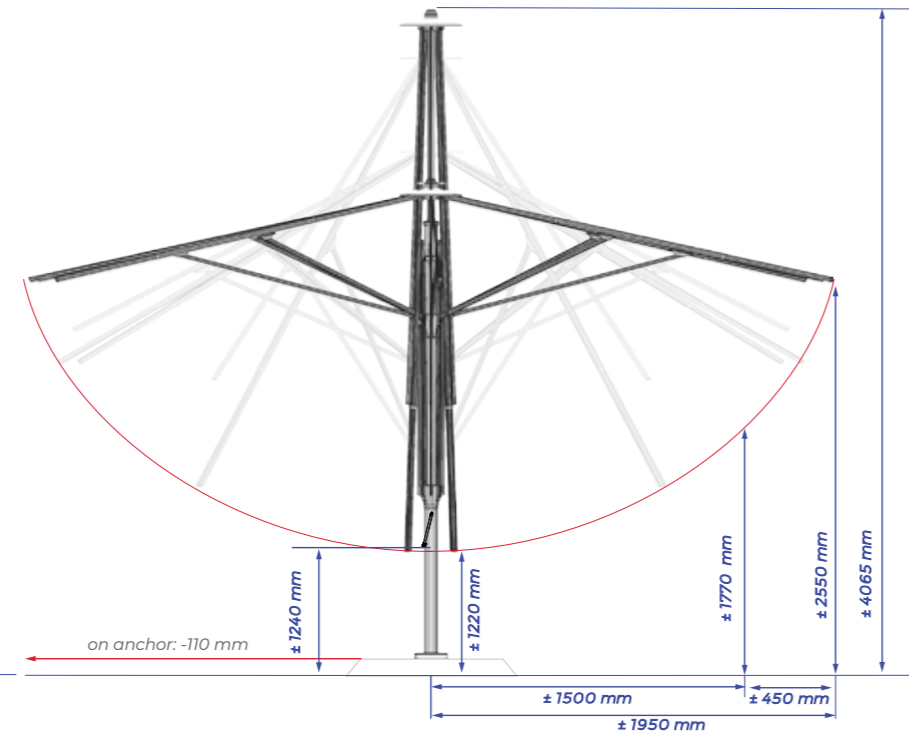

CHOOSE FROM 5 CLOTH COLOURS



SPECIFICATIONS & PRICES



DELIVERY FROM STOCK*

Item number	Description	Price in £ excl. VAT	Specifications
874.44.colour	Basto 400x400 cm	2499,-	Free protectioncover <input type="checkbox"/>
874.55.colour	Basto 500x500 cm	2649,-	Cantilever sunshade <input type="checkbox"/>
560.11.50	Tile base Basto (support is supplied with parasol)	429,-	Central pole <input type="checkbox"/>
574.60.50	Ground anchor Basto (support is supplied with parasol)	229,-	Telescopic system <input type="checkbox"/>

Lighting and heating can be found on pages 68-73
 Images of feet and anchors can be found on pages 82-83

Light included	<input type="checkbox"/>
Fade-resistant cloth	<input type="checkbox"/>
Pole in two parts	<input type="checkbox"/>
Tilttable	<input type="checkbox"/>
With rotating device 360°	<input type="checkbox"/>
Side inclination	<input type="checkbox"/>
Valance (without add. costs)	<input type="checkbox"/>
Operating system	winch
Weight cloth per m ²	300 grams
Integrated rib ends	<input type="checkbox"/>
Number of ribs	8
Closes over the table	<input type="checkbox"/>
Pole diameter	86 mm

TIMELESS FRAME COLOR



VIDEO



*While stocks last



SOLERO® P4 PRO

In some situations it's not desirable or even possible to anchor a parasol in your terrace. This might be solved by using a mobile parasol base, but this often turns out to be in everyone's way. Especially if you want to use every inch of your terrace or balcony, the Solero wall parasols make for a great alternative.

The Solero Prostor P4 wall parasol **Ø270 cm** will always be delivered to you with a built-in pressured gas spring. This allows for a very smooth handling! Using the handle this unique wall parasol can be fixed into a horizontal position with a touch. Additionally you can also extend the length of the black handle from 140 up to 180 cm.



EASY OPENING SYSTEM

Our patented 'Easy Opening System' makes using this parasol easy and will help save on space. By using the telescopic arm the parasol can be extended 140 to 180 cm from the wall. The Prostor P4 can be tilted horizontally up to 10 degrees, which can be very useful with a setting sun.

100% OLEFIN

The canvas of the parasol is 100% Olefin and is painted in the mass, it weighs 190 gramss per square meter and has a colorfastness of 7-8 on a scale of 8. Olefin is water resistant and filters over 97% of UV radiation; this is expressed as UPF 40+. The canvas can be washed and if necessary is easy to replace.

EYE-CATCHER

The arm and the frame of the parasol is finished in anodized aluminum, making the parasol lightweight and a real eye catcher in your backyard. A protective cover is provided free of charge, this allows you to greatly lengthen the lifespan of this nice wall mounted parasol.

DIMENSIONS

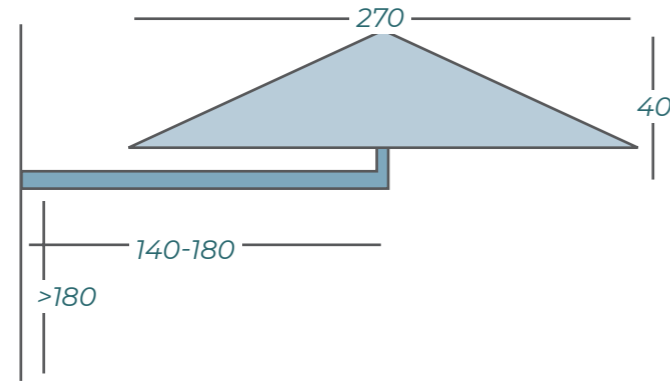

CHOOSE FROM 10 CLOTH COLOURS



SPECIFICATIONS



DELIVERY FROM STOCK*

Item number	Description
p4m.270.colour	P4 wall sunshade incl. wall fixation
p4m.100.00	Additional wall fixation
p4m1.270.colour	Prostor P4 Replacement cloth

Lighting and heating can be found on pages 68-73

Specifications	
Free protectioncover	yes
Cantilever sunshade	yes
Closes towards the pole	yes
Light included	optional
Fade-resistant cloth	yes 7-8/-
Pressured gas spring	yes
Tiltable	10 °
With rotating device	yes
Waterproof cloth	yes
Operating system	Fold & Push
Weight cloth per m ²	190 grams
Number of ribs	6
Possibility of logo printing	yes
Closes over the table	yes
Connectable with gutters	no
Electrically operated	no

PRICES ON REQUEST

TIMELESS FRAME COLOR



VIDEO



*While stocks last, if not available, production takes up to 3 weeks



SOLERO® P6 PRO

The Solero Prostor is much more than just a parasol, it's an easily retractable canopy with a lot of features. The setup consists of a central pole which can accommodate up to four parasols. Using the patented control system, including a gas spring, the parasols are easily collapsed. You can open or collapse every cloth individually. Possible sizes are **250x250 cm, 300x300 cm, 350 cm round** or **420 cm round**

Solero P6 Pro comes with a sound aluminum mast that allows 1, or up to 4 canvases to be mounted. Opening and closing is as simple as it's genius. With the one-move system the parasol slides into the open position. You don't have to be really strong to open this! The canvas is 100% acrylic and is painted in mass, it weighs 290 grams per square meter and has a colorfastness of 7-8 on a scale of 8. Acrylic is water resistant and filters out 95-100% of UV radiation, expressed as UPF 50+. The canvas is washable and if necessary easy to replace.



A PUSH IN THE RIGHT DIRECTION

The controls are extra light thanks to the stainless steel gas spring that compensates the weight of the parasol. Do you want to use the parasol in a wet- or sea climate? No problem, that's what the stainless steel gas spring is designed for.

ON THE GROUND OR ON THE WALL

This parasol is available as a wallmounted parasol in single or dual variations. The pole can be easily mounted to the wall with 2 brackets. That way you can enjoy a stylish parasol with a pole or tile pedestal. Unfortunately this isn't possible for our round variations. The framework for this parasol is RAL 9007 by default, this is a gray structured lacquer as shown in the photo. It's possible to get a black or white frame in case you need it, but this will have an additional cost and a longer lead time. You'll have the choice of RAL 9016 (white matte) or RAL 9005 (black, matte) and Alucopper.



FLEXIBLE IN THE HIPS

Move your parasol around effortlessly thanks to the swiveling wheels with brakes, this is only available for the P6 Uno parasol. Optional for the Prostor p6 tile pedestal is an aluminum cover, lacquered in the pole's color for a tile pedestal of 90x90 or 100x100 cm.

DIMENSIONS

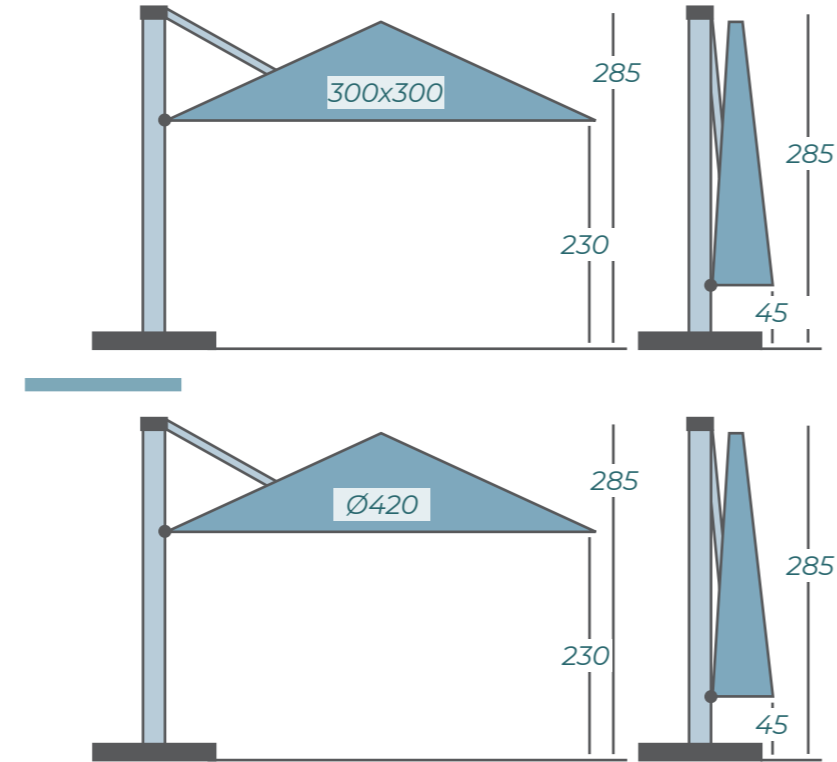
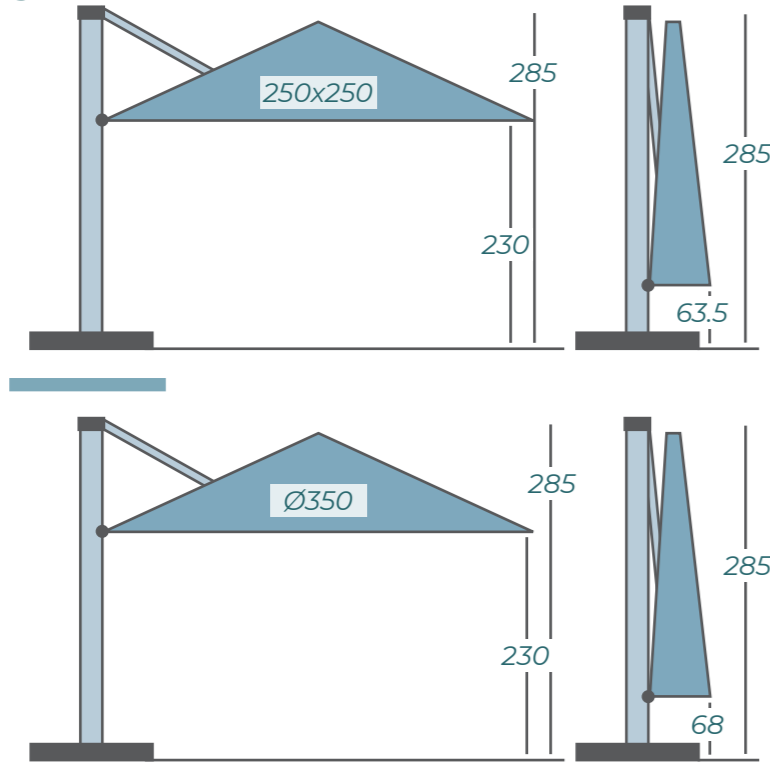

CHOOSE FROM 11 CLOTH COLOURS



POSSIBLE SETUPS PRICES ON REQUEST

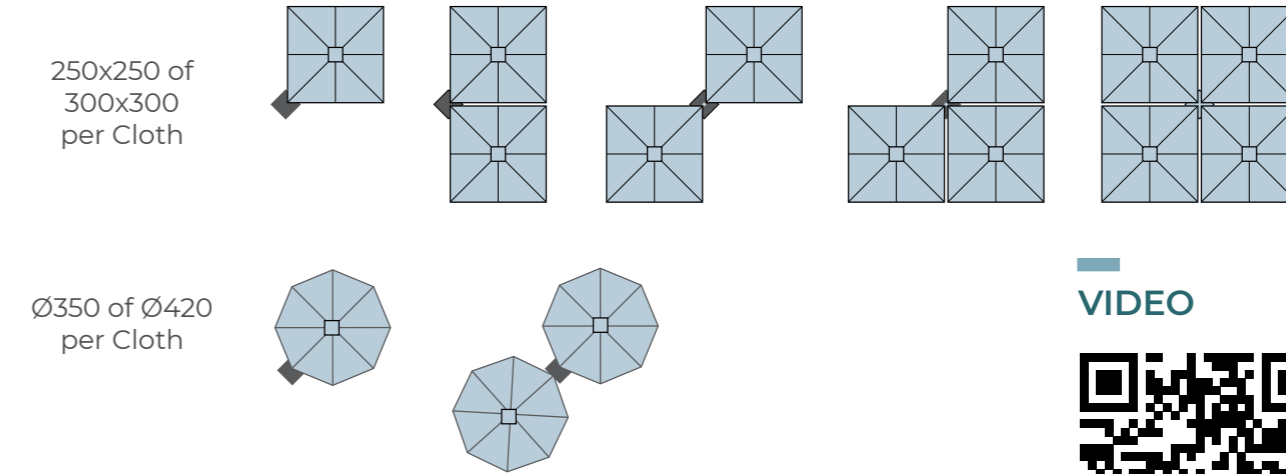

VIDEO

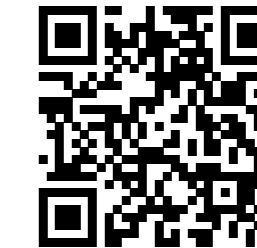

CHOOSE FROM 4 FRAME COLOURS

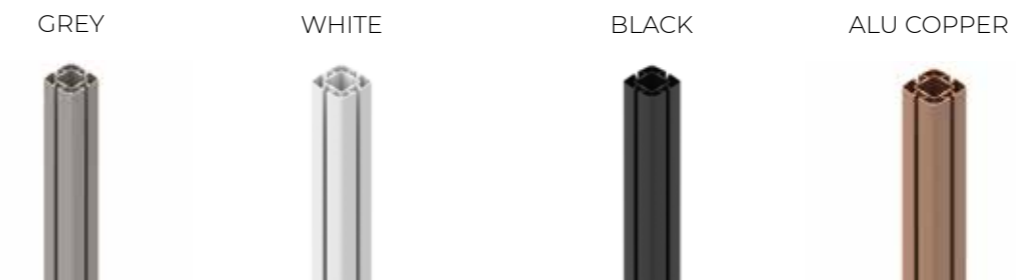

ON REQUEST

Specifications	
Free protectioncover	no
Cantilever sunshade	yes
Closes towards the pole	yes
Light included	optional
Fade-resistant cloth	yes 7-8/-
Pressured gas spring	yes
Tiltable	no
With rotating device	yes
Waterproof cloth	yes
Operating system	One-move
Weight cloth per m ²	290 grams
Number of ribs	8
Possibility of logo printing	yes
Closes over the table	yes
Connectable with gutters	yes
Electrically operated	Quattro 250



SOLERO® P7 PRO

The Solero Prostor P7 wall parasol is available in four sizes: two square editions of **250cm and 300cm** and a round version with a size of **350cm or 420cm diameter**. No matter which size you choose, the P7 wall parasol is always easily handled.

With the integrated gas spring supporting you, you'll open and collapse the parasol in a flash. Despite of its size, the Solero Prostor P7 is very easy to move left or right. As the weight of this space saving parasol is smartly shared between the top and bottom rotating brackets, you'll instantly move the shadow to where you want it to be. The canvas is 100% acrylic and is painted in mass, it weighs 290 grams per square meter and has a colorfastness of 7-8 on a scale of 8. Acrylic is water resistant and filters out 95-100% of UV radiation, expressed as UPF 50+. The canvas is washable and if necessary easy to replace.



SUPER-LIGHT OPERATION

The controls are extra light thanks to the steel gas spring that compensates the weight of the parasol. Do you want to use the parasol in a wet- or sea climate? Then the optional stainless steel gas spring is definitely recommended.

CHOOSE FROM 4 FRAME COLOURS

The framework for this parasol is RAL 9007 by default, this is a gray structured lacquer. It's possible to get a black or white frame in case you need it, but this will have an additional cost and a longer lead time. You'll have the choice between RAL9007 (gray), RAL 9016 (white matte) or RAL 9005 (black, matte) and Alucopper. The Prostor P7 can be mounted to the wall with 2 adjustable brackets. The P7 wall parasol has an optimal turn when mounted on a corner. The locking axis helps lock the parasol down so it doesn't turn in the wind.

EASILY MANEUVERABLE

Move your parasol around effortlessly thanks to the swiveling wheels with brakes, this is only available for the P7 Uno parasol. Optional for the Prostor P7 tile pedestal is an aluminum cover, lacquered in the pole's color for a tile pedestal of 90x90 or 100x100 cm.

DIMENSIONS

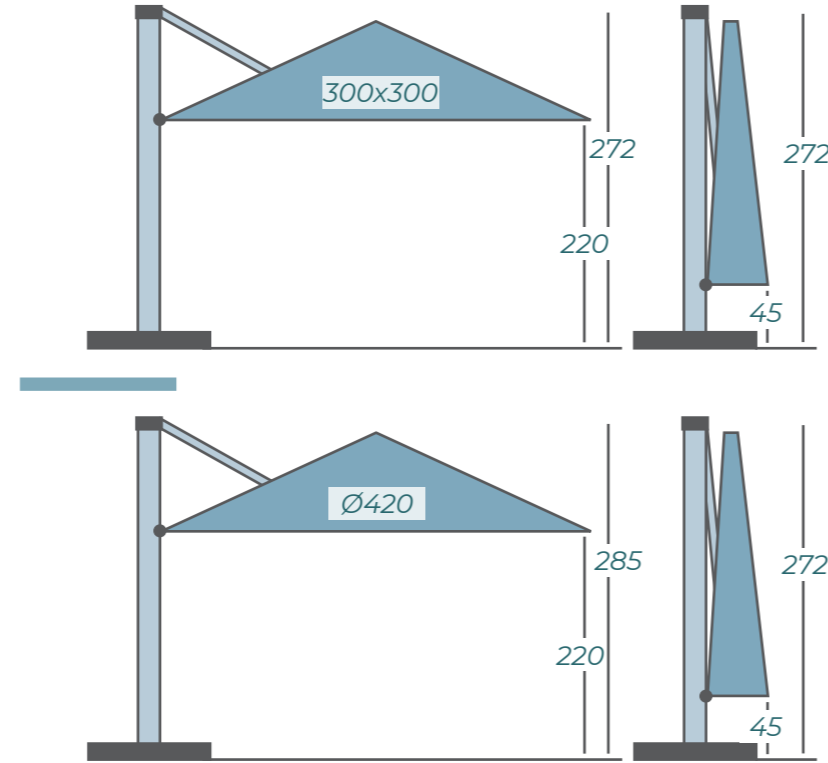
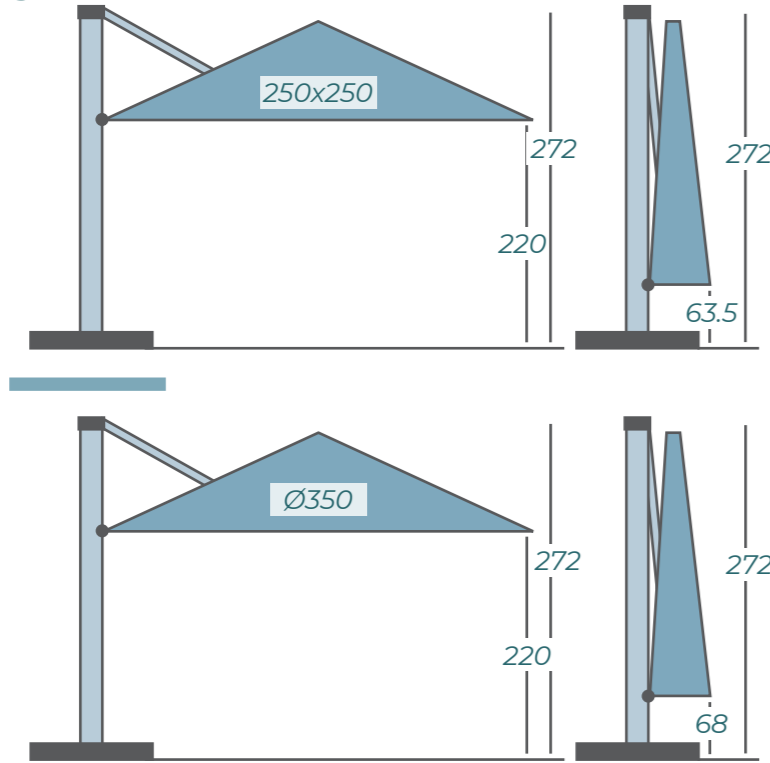

CHOOSE FROM 11 CLOTH COLOURS



POSSIBLE SETUPS

PRICES ON REQUEST

250x250 or 300x300 per Cloth

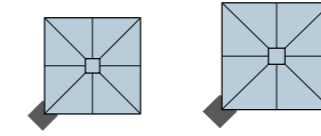

Ø350 or Ø420 per Cloth

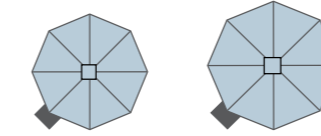

CHOOSE FROM 4 FRAME COLOURS

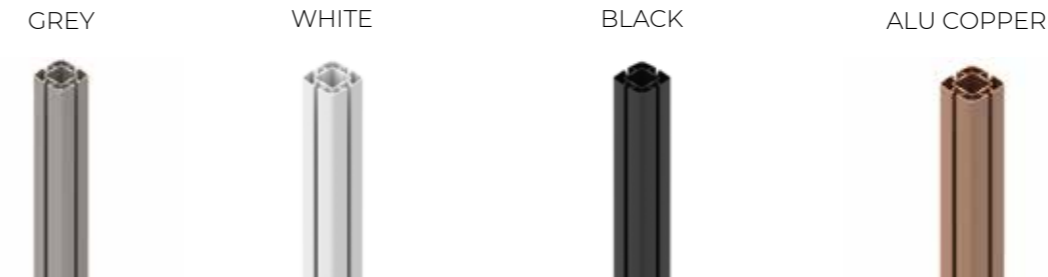

VIDEO



ON REQUEST

Specifications

Free protectioncover	no
Cantilever sunshade	yes
Closes towards the pole	yes
Light included	optional
Fade-resistant cloth	yes 7-8/-
Pressured gas spring	yes
Tiltable	no
With rotating device	yes
Waterproof cloth	yes
Operating system	One-move
Weight cloth per m ²	290 grams
Number of ribs	8
Possibility of logo printing	yes
Closes over the table	yes
Connectable with gutters	yes
Electrically operated	no



HEATING & LIGHTING

It's been a nice day, the sun is slowly setting and it's starting to cool down. With the help of heating and lighting we can bring back the sun for a little while on the patio or in your backyard.

Our patio heaters are perfect for use in hospitality but are also available for consumers. They create a comfortable atmosphere and are available in multiple colors, the design isn't ostentatious but looks stylish. The heaters are easy to install, easy to direct and suitable both in- and outdoors, the machine is lightweight making it very easy to move. An added advantage is that 92% of the electricity is converted to heat.



IMMEDIATELY EFFECTIVE HEAT

The great thing about infrared lights is that they warm people, instead of air, this means there's no lead to build up heat and effective heat is created immediately after turning it on. An added advantage is that 92% of the electricity is converted to heat.

A GREEN CHOICE

We also thought about the environment, working with infrared means there's no exhaust gases; there's no use of oxygen after all. There's no (direct) CO2 emission and while in use there's no pollution or noise through air- and dust circulation.

SPLASH-PROOF

The heaters are splash proof and made of weatherproof aluminum, the special isolation prevents overheating of the housing and the grate at the front prevents touching of the halogen lamp. There's no blinding through the use of filtered lamps. Each lamp has around 5000 hours of use.

CHOOSE FROM 2 HEATERS



Product	Heliosa 11
Wattage	1500 watt
Burning hours	5000-7000
Dimensions	450mm x 130mm x 90 mm
Weight	1 kg
Lamp	Amber light
Protection rating	IP X5 (jet-proof)
Available colours	Anthracite
Connection	5 m cord with separate plug
Fastening	Wall/rib bracket free
Surface area with 17°C	heats 12 - 15 m ²

Product	Heliosa 66
Wattage	2000 watt
Burning hours	5000-7000
Dimensions	510mm x 160mm x 215mm
Weight	2.1 kg
Lamp	Amber light
Protection rating	IP X5 (jet-proof)
Available colours	Anthracite
Connection	5 m cord with separate plug
Fastening	Wall/rib bracket free
Surface area with 17°C	heats 20 - 25 m ²



AND 2 TYPES OF LIGHTING



Product	Solero@ Accento*
Suitable for mast diameter	34-50mm
LED	Yes
Weight	750 gramss
Fastening	clamps onto mast



Product	Solero@ Lux
Suitable for mast diameter	34-50mm
LED	Yes
Weight	750 gramss
Fastening	magnet strip
Remote control	Yes

VIDEO



*Solero Accento comes for free with an order of a Cielo Pro, Laterna Pro, Fratello Pro and Palestro Pro

	Heliosa 11	Heliosa 66	Accento	Lux
Sublimo			X	
Vaticano			X	
Teatro	X		X	X
Cielo	X		free	X
Laterna	X		free	X
Fratello	X		free	X
Fuorto	X			X
Patio	X		X	X
Lasagna	X		X	X
Presto	X			X
Palestro	X		free	X
Maestro	X			X
Basto	X			X
P4			X	
P6	X			X
P7	X			X



PRICES



DELIVERY FROM STOCK*

Item number	Description	Price in £ excl. VAT
668.15.00	Solero Heliosa 11 sunshadeheater	259,-
P67.160.RVSS	Stainless steel rib brace Heliosa 11/77 for Solero	42,-
P67.160.RVSH	Stainless steel rib brace Heliosa 11/77 for Prostor	44,-
668.15.66	Solero Heliosa 66 wallheater	449,-
668.15.88	Solero Heliosa pole fixation up to 66mm	94,-
668.15.99	Solero Heliosa pole fixation up to 100mm	97,-
668.15.33	Solero Heliosa fixation for 3 heaters	240,-
668.15.10	Solero Heliosa remote control up to 3500 watt	144.50,-
535.24.54	Accento click-on sunshadelight	229,-
535.35.99	Solero Lux LED strips sunshadelight + remote	198.34,-

*While stocks last



GUTTERS, COVERS & CANVASES

It might not be the first thing you think of, but that doesn't make it any less important: the gutters, covers and canvases for your parasol. Like no other, we understand how important it is to get a good cover with your parasol. You'll protect the canvas against the weather and will help keep your canvas as new. After a few years you might be done with the color of your parasol, in that case we can help you with a replacement canvas. We have all canvases in stock and can be easily exchanged.

We do have cases where a truck hits a hospitality parasol, accidentally bending the ribs. This is extremely difficult because it immediately makes your patio look poor. In most cases however, we thankfully have spare parts available or if necessary order new parts which would be ready within 1 week. This goes for a replacement canvas, or a complete mast, as well. These parts are in stock, so that we'll be able to deliver quickly to you.



GUTTERS

The easiest way to connect parasols is through canvas gutters, they're often called rain gutters too. We offer 2 types of canvas gutters; the Solero PVC canvas gutters, and the Prostor canvas gutters. The Solero PVC canvas gutters are fastened through clasps that click in place, which are mounted by screwing them into the ribs, they're available in all lengths and in the colors natural, gray and black, the width of these gutters is 60 cm maximum. The Prostor canvas gutters work with a zipper and are available in 2 lengths: 250cm or 300cm in the exact color of your parasol's canvas.

COVERS

Indispensable to keep the canvas of your parasol in good condition: the protective cover. A protective cover is available for every type of parasol, the Solero covers are provided free of charge when buying a parasol, but are available separately as well. We don't offer any warranty on these covers because of the severe weather they're open to. The covers in the Prostor collection are made of a heavier quality and are available in the colors black or gray.

CANVASES

Despite the unmatched quality of the Solero O'Bravia canvas it does happen that a canvas needs to be replaced. Sometimes the weather takes hold and it's hard to remove the stains. Especially because of this we offer separate canvases, which include 4 years of colorfastness warranty, so that you're ensured of years of a deeply colored canvas. Our canvases protect against UV-radiation, are waterproof and above all colorfast. Different sizes and colors are available.

CHOOSE FROM 5 PVC COLOURS FOR GUTTERS



CHOOSE FROM 7 SOLERO CLOTH COLOURS*



CHOOSE FROM 11 PROSTOR CLOTH COLOURS



*The available colours are specified per parasol on the product page

PRICES

Item number	Description	Price in £ excl. VAT
577.30.colour	Solero gutter PVC 300x60 cm	239,-
577.33.colour	Solero gutter PVC 330x60 cm	279,-
577.40.colour	Solero gutter PVC 400x60 cm	299,-
577.50.colour	Solero gutter PVC 500x60 cm	369,-
525.95.04	Cover Vaticano/Teatro/Sublimo	67.50,-
525.99.04	Cover Cielo (Plus)	80,-
532.99.04	Cover Laterna	82.50,-
532.99.04	Cover Lasagna	82.50,-
532.89.04	Cover Fratello	85.00,-
533.70.04	Cover Presto	82.50,-
536.33.04	Cover Patio	80,-
542.99.04	Cover Palestro	102.50,-
536.98.04	Cover Maestro	99,-
574.94.04	Cover Basto 400x400 cm	149,-
574.95.04	Cover Basto 500x500 cm	159,-
999.33.28	Tear-Aid Repair set Type A	25,-



DELIVERY FROM STOCK*

521.20.colour	Cloth Sublimo 200x200 cm	125,-
521.30.colour	Cloth Sublimo 300 cm	129,-
526.27.colour	Cloth Cielo	209,-
526.29.colour	Cloth Cielo Pro	209,-
527.27.colour	Cloth Teatro	125,-
532.34.colour	Cloth Laterna 300x300 cm	289,-
532.36.colour	Cloth Laterna 350 cm	289,-
532.85.colour	Cloth Fratello	289,-
535.34.colour	Cloth Patio	279,-
533.34.colour	Cloth Presto 330x330 cm	309,-
543.83.colour	Cloth Palestro 4x4 en 3x4 m	499,-
533.04.colour	Cloth Presto 400 cm	309,-
536.43.colour	Cloth Maestro 300x400 cm	449,-
536.44.colour	Cloth Maestro 400x400 cm	499,-
575.44.colour	Cloth Basto 400x400 cm	499,-
575.55.colour	Cloth Basto 500x500 cm	749,-

*While stocks last



PRINTING

Especially companies dealing in hospitality like to have their company name or logo printed on their parasol, to increase the recognizability of their brand. Printing on a canvas takes quite some effort, that's why we'll gladly do it for you. We work with the best printers who work carefully and pay close attention to get a beautiful result that fits with your style. Solero uses two methods to print a logo or text on canvas: plotting and screen printing. Plotting means that the logo is cut from foil and pressed onto the canvas with heat. This is done under high temperatures so that the glue of the foil binds properly to the canvas. Because of the immense heat on the material, a printer can't heat the same piece of cloth more than 3 or 4 times, otherwise the canvas would shrink. In those cases, screen printing offers a solution, because it doesn't use any heat. With screen printing a screen is put over a frame while the ink is pressed through the open parts of the screen. The screen is based on a template of the logo that needs to be used on the canvas. Both methods are used regularly by us, but in the long term a logo that's been screen printed remains brighter and better.



THE (DIS)ADVANTAGES OF PLOTTING

The advantages of plotting:

- Quick turnaround of 1 week
- Cheaper in smaller quantities
- Printing is colorfast
- Metallic colors are an option

The disadvantages of plotting:

- Limited choice of colors
- A logo with many colors is not possible (>3 colors)
- Plotting is more sensitive to UV-radiation than screen printing

THE (DIS)ADVANTAGES OF SCREEN PRINTING

The advantages of screen printing:

- A great price when ordering many logo's
- All colors available
- Printing is colorfast

The (dis)advantages of screen printing:

- It's very costly with smaller quantities
- Delivery time is around 2 to 3 weeks
- Impossible to do large prints

.EPS-FORMAT

Each logo is unique and because of that it's difficult to give a good pricing indication without having seen the logo first. Because of that, we always ask that you send us the logo in EPS format, so we can request a proof from the printer and make a good offer for you. We're a great partner for larger projects, and starting at 100 pieces the prices will, of course, be a lot better. A large project does increase the lead time.

POSSIBLE POSITIONING FOR YOUR LOGO

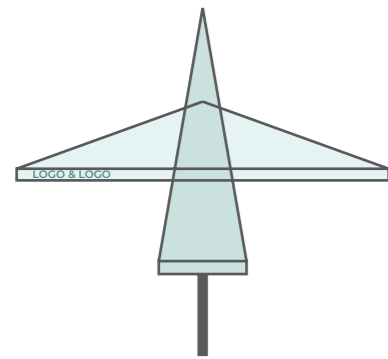
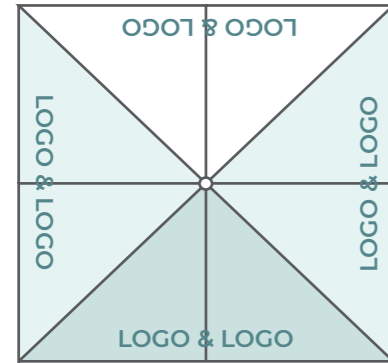

CHOOSE FROM DIFFERENT FILM COLOURS

P.S. Film - P.S. Film Extra - P.S. Stretch - P.S. Hi-Tech

Con supporto adesivizzato - Adhesive backing - Rückklabender Polyesterträger
 Stacco a caldo o a freddo - Warm or cold peel - Warm oder kalt abziehen

**Disponibile anche in P.S. 60/100 / available also in P.S. 60/100 / auch in P.S. 60/100 verfügbar
 Disponibile anche in P.S. 30/50 / available also in P.S. 30/50 / auch in P.S. 30/50 verfügbar

A001 Bianco / white / Weiss / *10001	A002 Rosa / pink / Rosa / *10002	A003 Blu / blue / Blau / *10003	A004 Marrone / brown / Braun / *10004
A005 Giallo / yellow / Gelb / *10005	A006 Verde / green / Grün / *10006	A007 Rosso / red / Rot / *10007	A008 Nero / black / Schwarz / *10008
A009 Arancione / orange / Orange / *10009	A010 Blu scuro / dark blue / Dunkelblau / *10010	A011 Verde scuro / dark green / Dunkelgrün / *10011	A012 Grigio / grey / Grau / *10012
A013 Rosso scuro / dark red / Dunkelrot / *10013	A014 Blu chiaro / light blue / Hellblau / *10014	A015 Verde chiaro / light green / Hellgrün / *10015	A016 Marrone scuro / dark brown / Dunkelbraun / *10016
A017 Rosso vivo / bright red / Rot / *10017	A018 Blu medio / medium blue / Mittelblau / *10018	A019 Verde medio / medium green / Mittelgrün / *10019	A020 Marrone medio / medium brown / Mittelbraun / *10020
A021 Rosso scuro / dark red / Dunkelrot / *10021	A022 Blu scuro / dark blue / Dunkelblau / *10022	A023 Verde scuro / dark green / Dunkelgrün / *10023	A024 Grigio scuro / dark grey / Dunkelgrau / *10024
A025 Rosso vivo / bright red / Rot / *10025	A026 Blu medio / medium blue / Mittelblau / *10026	A027 Verde medio / medium green / Mittelgrün / *10027	A028 Marrone medio / medium brown / Mittelbraun / *10028
A029 Rosso scuro / dark red / Dunkelrot / *10029	A030 Blu scuro / dark blue / Dunkelblau / *10030	A031 Verde scuro / dark green / Dunkelgrün / *10031	A032 Grigio scuro / dark grey / Dunkelgrau / *10032

Siser

TARGET PRICES



2-4 WEEKS*

Dimensions logo plotting	Price per logo in 1 colour £ excl. VAT
50x17 cm	39,-
70x17 cm	48,-
80x17 cm	54,-
100x17 cm	60,-
130x17 cm	72,-
50x30 cm	52.80
80x30 cm	74.40
100x30 cm	88.20
130x30 cm	108,-
50x50 cm	76.20
80x50 cm	111.60
100x50 cm	135,-
130x50 cm	169.20
60x60 cm	102,-

Dimensions screen printing	Price per logo in 1 colour £ excl. VAT
Starting costs	90,- per colour
40x50 cm >10 pc	48,-
40x50 cm >25 pc	45.60
40x50 cm >50 pc	43.20
40x50 cm >100 pc	42,-
50x70 cm > 10 pc	57.60
50x70 cm > 25 pc	55.20
50x70 cm > 50 pc	52.80
50x70 cm > 100 pc	51.60

*Depends on the chosen printing method

GROUND ANCHORS AND FEET

Every parasol needs a different base. There are often even different types of feet suitable for one parasol. Below you will find an overview of the available accessories per parasol. In most cases, you need 40x40x4 cm tiles which you can stack together to create sufficient ballast.

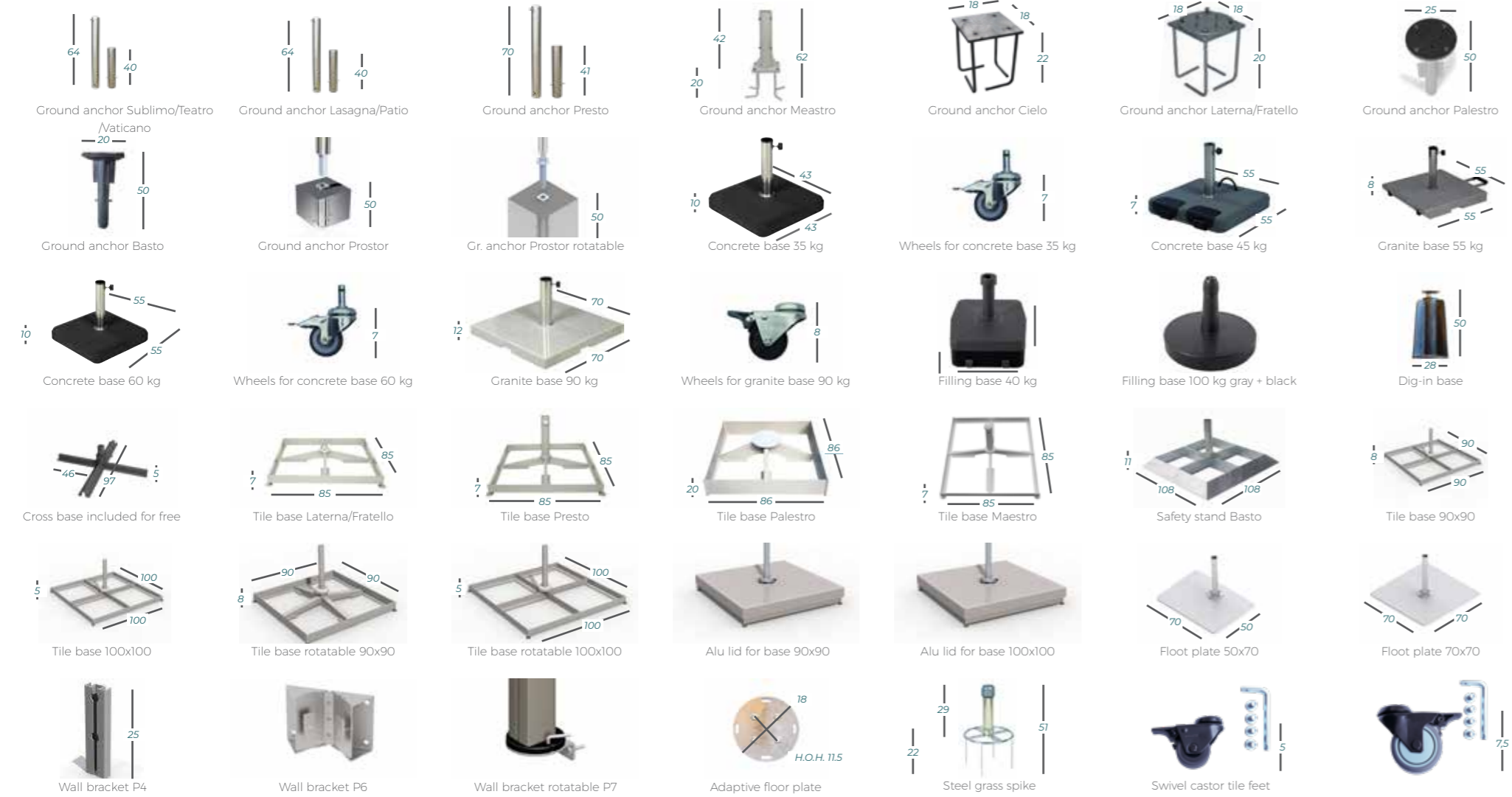

	Sublimo	Vaticano	Teatro	Cielo	Laterna	Lasagna	Fuerto	Fratello	Patio	Palestro	Presto	Maestro	Basto	P4	P6	P7
SST Ground anchor 40 mm	X	X	X													
SST Ground anchor 51 mm						X			X							
SST Ground anchor 66 mm											X					
Ground anchor 83 mm												X				
Ground anchor Cielo				X												
Ground anchor Laterna/Fratello					X			X								
Ground anchor Palestro										X						
Ground anchor Basto													X			
Ground anchor Prostor															X	
Gr. anchor Prostor rotatable																X
Concrete base 35 kg	X	X	X													
Wheels for concrete base 35 kg	X	X	X													
Concrete base 45 kg	X	X	X													
Granite base 55 kg	X	X	X			X			X							
Concrete base 60 kg						X			X							
Wheels for concrete base 60 kg						X			X							
Granite base 90 kg											X					
Wheels for granite base 90 kg											X					
Filling base 40 kg	X		X													
Filling base 100 kg gray + black						X			X							
Dig-in base				X	X			X								
Cross base included for free				X												
Tile base Laterna/Fratello					X			X								
Tile base Presto											X					
Tile base Palestro								X		X						
Tile base Maestro												X				
Swivel castor tile feet					X			X			X	X				
Safety stand Basto													X			
Tile base 90x90															X	
Tile base 100x100															X	
Tile base rotatable 90x90																X
Tile base rotatable 100x100																X
Alu lid for base 90x90															X	X
Alu lid for base 100x100															X	X
Floor plate 50x70															X	
Floor plate 70x70															X	
Wall bracket P4														X		
Wall bracket P6															X	
Wall bracket rotatable P7																X
Adaptive floor plate					X			X								
Steel grass spike	X	X	X			X			X							
Swivel castor tile feet				50 mm	50 mm			50 mm			75 mm	75 mm			Prostor's	Prostor's

P O R



T F O



L I O

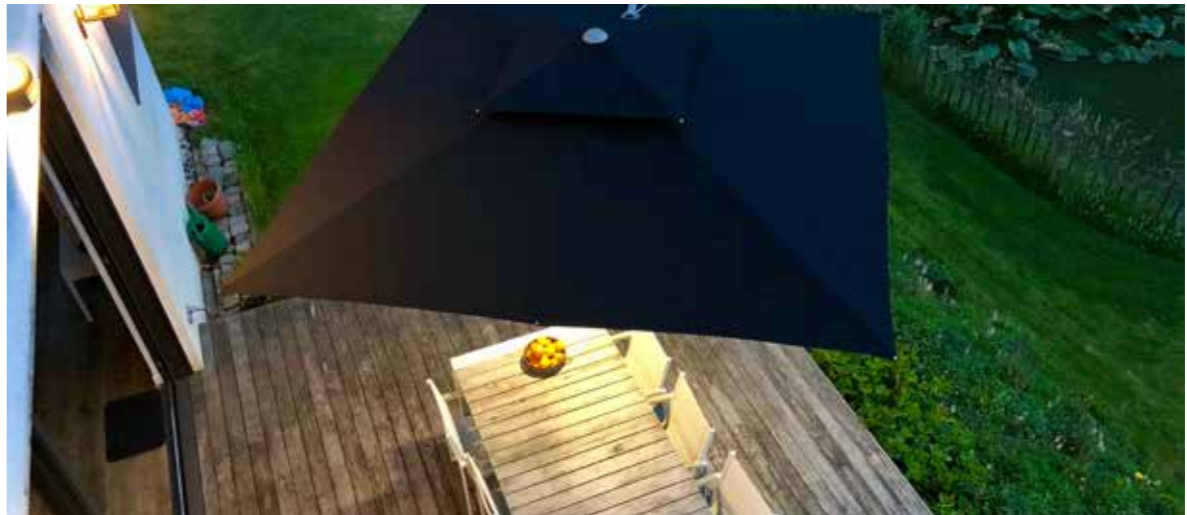



COLOURFASTNESS

The light- or colorfastness of our parasols is largely dictated through the use of colors. The Solero parasol canvases are painted down to the core of the fiber, for example like a carrot that's perfectly orange through and through. In comparison to other canvases that are painted after being woven, giving them just a superficial coloring. Cut a radish in half and you'll know what we mean: the outside is red, but the inside has no pigment whatsoever. Our coloring method gives the canvas a great resistance against solar radiation, the black canvas will remain perfectly black for up to 4 years.

WATER REPELLANT

Besides the lightfastness, the water repellent properties are an important factor of the canvas. Of course you'd want you and your guests to stay dry under the canvas during summer rain. This property is defined by the water column. A water column says something about the amount of water that a parasol canvas can withstand before it starts to seep through. A water column of 300mm, like the Solero parasol, means that the canvas will not allow water through until the pressure reaches the comparable weight of 30 cm of standing water. The water column indicates how many millimeters of water per square centimeter can be on the canvas before it starts to leak.

PROTECTIVE

Solero parasols form a good protection against harmful influences of exposure to sunlight. With the decay of the ozone layer less and less ultraviolet radiation is filtered. This means a great quality canvas offering optimal protection becomes more and more important. All canvases filter 100% of the harmful ultraviolet radiation. We note this with a UPF factor of 50+. Exposure to too much ultraviolet radiation can discolor the skin to red, burn it, or even lead to skin cancer. Parasols made by Solero have a UPF value of 50+ and offer good protection, but always stay alert! Ultraviolet radiation is also reflected off the water, snow, glass and sand. Indirectly your skin will still be exposed to radiation.

CONVENIENT DIMENSIONS

To simplify the installation of your parasol, we have listed all the distances from the middle of the mast to the beginning and end of the cloth below. If you still have doubts, please contact us or one of our dealers.

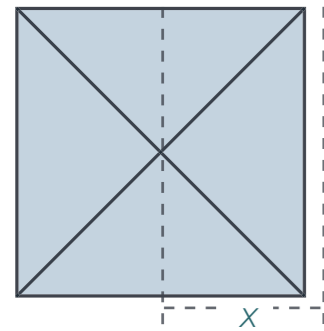

SUBLIMO PRO 200X200 X=1000 MM
SUBLIMO PRO Ø300 X=1500 MM

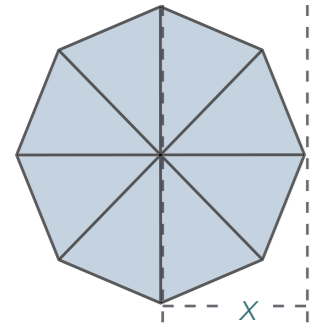

TEATRO PRO Ø250 X=1350 MM

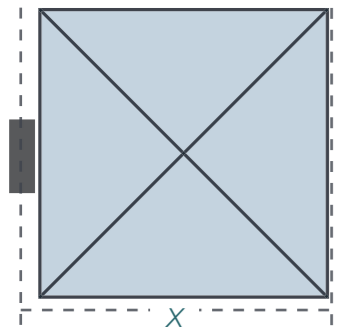

LATERNA PRO 300X300 X=3100 MM
LATERNA PRO Ø350 X=3600 MM

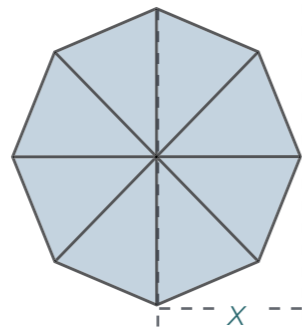

VATICANO PRO Ø250 CM X=1250 MM

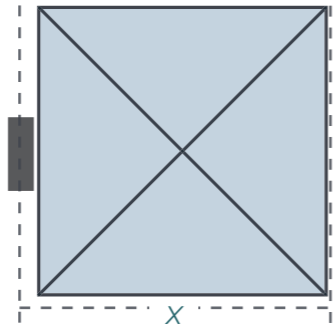

CIELO PRO 260X260 X=2910 MM

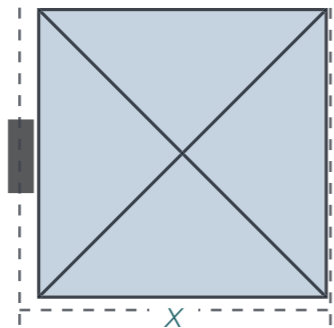

FRATELLO PRO 300X300 X=3250 MM

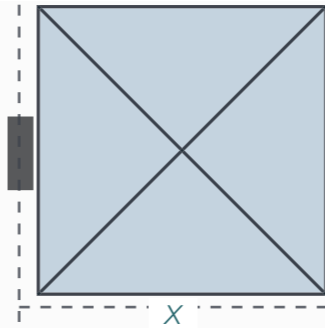

FUERTO PRO 300X300 X=3160 MM

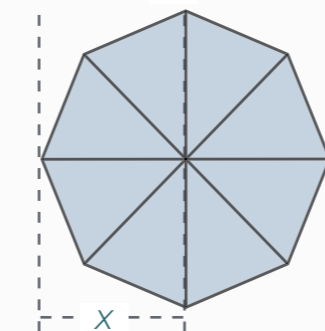

LASAGNA PRO Ø330 X=1650 MM

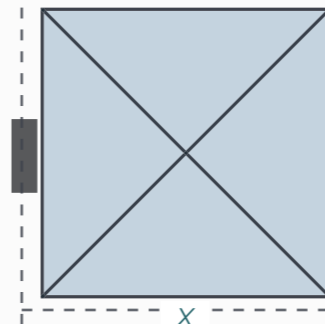

PALESTRO PRO 300X400 X=3140 MM
PALESTRO PRO 400X400 X=4140 MM

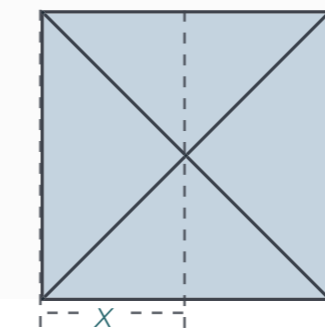

BASTO PRO 400X400 X=2000 MM
BASTO PRO 500X500 X=2500 MM

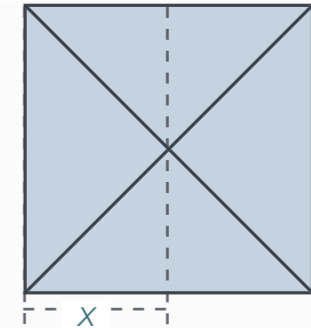

PATIO PRO 300X300 X=1500 MM

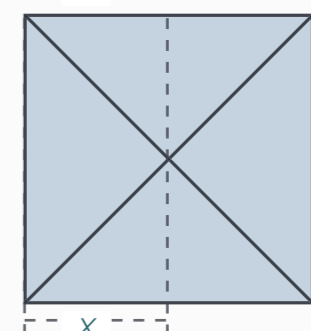

PRESTO PRO 330X330 X=1650 MM
PRESTO PRO Ø400 X=2000 MM

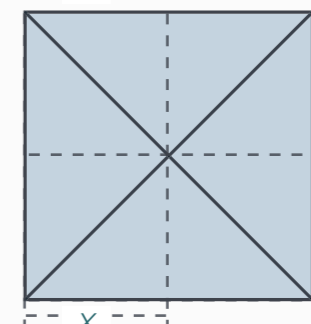

MAESTRO PRO 300X400 X=2000 MM
MAESTRO PRO 300X400 Y=1500 MM
MAESTRO PRO 400X400 X=2000 MM

SOLERO & TREES FOR ALL

Firmly rooted in the ground, shield the sun, and repel water; Solero parasols have much in common with trees. Unfortunately, mother nature still outsmarts us. Because our parasols are not able to transform harmful CO2 in oxygen. We really need trees for this. And a whole lot, too!



NOT TO GO IT ALONE

We are not wasting any time, so we have started planting an actual Solero company forest. Not on our own: between 2020 and 2022 as many as two thousand trees will be planted by us in collaboration with Trees for All.

Every year, 10 billion trees more are cut down than there are planted, and the lungs of the earth are disappearing bit by bit. Trees for All wants to reverse that process. "Trees take care of us, that's why we take care of trees." That's the motto of Trees for All.

Everyone wanting to contribute to a green earth and a healthy climate can support their work. Along with Trees for All.

TREES TAKE CARE OF US,
THAT'S WHY WE TAKE
CARE OF TREES.



SOLERO'S CONTRIBUTION

For each parasol sold at or Dutch webshop, we plant a tree. That is how we will plant our own Solero company forest in two years. 1,000 trees will be planted in the Netherlands, the other 1,000 will be planted on a project abroad.

GREEN BUSINESS PARTNER OF TREES FOR ALL SINCE 2020



TERMS & CONDITIONS 2022

ARTICLE 1: DEFINITIONS

1.1. In these Terms & Conditions, the following words will have the following definitions: Solero Trading: The company blancheh limited liability Solero Trading B.V., also trading as Solero Parasols, located at the Industrieweg 210, 5683 CH in Best, The Netherlands, registered at the Dutch Chamber of Commerce under file number 17217199. Buyer: The person or legal entity who enters into an Agreement blancheh Solero Trading by purchasing a Product and either provides for financial compensation, provides for another reimbursement or compensation or who receives a product as a result of a promotional offer made by Solero Trading. Product: The product or products ordered or received by the Buyer as a result of the Agreement and which forms the sum of all elements of the order confirmed in the Agreement. Delivery: The moment on which the Product is delivered to Buyer and the responsibility and management is transferred to the Buyer. Agreement: The Agreement to which Solero Trading and Buyer enter into by mutual confirmation in writing and that has led or will lead to a Delivery.

ARTICLE 2: APPLICABILITY

2.1 These Terms & Conditions are applicable on all Agreements between Solero Trading and Buyer, unless explicitly agreed upon otherwise in writing.
 2.2 The applicability of any conditions maintained by Buyer are explicitly rejected unless agreed upon otherwise in writing. If any conditions of Buyer do apply to the Agreement, the Terms & Conditions of Solero Trading will still be applicable for those situations wherein Buyer's conditions do not provide for.
 2.3 If any of the conditions or provisions in these Terms & Conditions would be nullified or declared void by an authorized entity such as a Court, all the other provisions will remain valid and intact. If this situation would occur, both parties in the Agreement are bound to determine replacing conditions in which the spirit and the economic effect of the original condition(s) are being maintained to the largest possible degree.
 2.4 If these Terms & Conditions are offered to the Buyer in any other language than Dutch, the non-Dutch version will only serve informational purposes. If any differences in the actual text or possible interpretations occur between different linguistic versions of these Terms & Conditions, the Dutch version will always prevail.
 2.5 If any situation would arise for which these Terms & Conditions do not provide, parties will be bound to determine new conditions that maintain the spirit of the conditions which have been determined.

ARTICLE 3: QUOTES AND OFFERS

3.1 All quotes, offers and proposals of Solero Trading are non-committal for Buyer, unless explicitly agreed upon otherwise in writing.
 3.2 All quotes, offers and proposals of Solero Trading are valid for 30 days, unless another term has been set forward in the quote or has been agreed upon between parties in writing. Solero Trading is only bound by the offer if the Buyer has accepted this offer during its validity.
 3.3 The quote will become an Agreement from the moment the Buyer has agreed to its terms, either in writing, by fax or by email and only upon written confirmation that this has been received by Solero Trading.
 3.4 If the accepted offer has been changed unilateral by Buyer, Solero Trading will not be bound to the Agreement, unless explicitly agreed upon otherwise.
 3.5 If the offer consists out of multiple elements or Products, Solero Trading will not be bound to deliver part of this Agreement against the corresponding price in the offer.
 3.6 Pricing, discounts and special offers made in a specific offer are only valid for that offer or quote and do not automatically apply for future orders.

ARTICLE 4: TIME AND LOCATION OF THE DELIVERY

4.1 Delivery of the Product will be done at the address provided by the Buyer and at the expense of Buyer, unless explicitly agreed upon otherwise.
 4.2 Any Delivery moment agreed upon by Solero Trading will always be a best effort moment and is never a strict deadline. Exceeding this moment does not qualify Buyer for receiving compensation or compensation of damages, nor does he gain the right to terminate the Agreement. Once the Delivery term has been exceeded, Buyer shall send a notice of default to Solero Trading, providing for a new and reasonable deadline to perform the Delivery.
 4.3 Solero Trading is entitled to deliver the Product in parts, in which case every partial delivery may be invoiced separately.
 4.4 If Buyer defaults in accepting the Product, Solero Trading is entitled to either store the Product at the full risk and expense of Buyer, or to terminate the Agreement either entirely or partially, blancheHout judicial intervention and notblanchehstanding the right of Solero Trading to claim full compensation for damages occurred.

ARTICLE 5: RECLAMATION AND TERMINATION

5.1 Upon receiving the Product, Buyer will immediately inspect the Product and be convinced of a fully operational and well delivered Product. Any reclamation blancheh regards to the state of the delivered Product must be send to Solero Parasols immediately but never later than 14 days. After you send the reclamation, you have another period of 14 days for the return process. In absence of which Solero Trading will not be liable for any damages of the Product that occurred previous to or during the Delivery.
 5.2 If Solero Trading accepts a reclamation entirely or partially, it may chose freely to either terminate the Agreement blancheHout judicial intervention and taking back the Product, or to replace the Product blancheHout adding extra charges to the Buyer, or to provide for a reasonable discount on the sales price to the Buyer after which the Buyer may retain the Product.

ARTICLE 6: TRIAL PERIOD AND RIGHT OF BLANCHEHDRAWAL

6.1 Any purchase is made by a consumer is subject – in accordance blancheh Dutch law (Art. 7:5 BW) – to the right to return any good(s), blancheHout being obliged to state a reason for doing so, blanchehin fourteen business days. This term commences on the day the ordered goods are delivered. If the buyer has not returned the goods to Solero Trading upon the passing of this term, the purchase will become irrevocable. The buyer is obliged to send a written confirmation to Solero Trading blanchehin fourteen business days, stating that the goods will be returned. In addition, the buyer is obliged to collect and save proof that the goods have been sent back blanchehin the fourteen business day term, e.g. by retaining a proof of delivery from the shipment company. Any goods which are sent back are to be contained in the original casing, including any accessories, documentation or any other item received upon order; all in mint condition and/or factory state. If the products have been used, burdened or damaged in any way while in possession of the buyer, the right of blanchehdrawal as meant in this paragraph is automatically void. Subject to all which has been determined in this paragraph, Solero Trading will reimburse the full purchase amount to the buyer blanchehin fourteen days after having received the return shipment in good state. The costs and risks of returning the items are entirely borne by the buyer. Per explicit request, Solero Trading may also assign her carriers to collect the shipment, after which the entire purchase amount minus the shipment costs will be reimbursed blanchehin fourteen days. 6.2 The right of blanchehdrawal is not applicable to goods and services of which the prices are bound to fluctuations on the financial markets, on which Solero Trading has no influence. Nor is the aforementioned right applicable to goods which have been manufactured in accordance blancheh client's specification, such as tailor-made parasols, printed fabrics or other products blancheh an obvious personal character.

ARTICLE 7: PAYMENT CONDITIONS

7.1 Solero Trading retains the right to demand, at any given moment including the period between entering into the Agreement and the Delivery, an advance payment, an irrevocable letter of credit, a bank security, or another security if reasons of its own would come to exist. If Buyer cannot or will not provide for such a security, Solero Trading has the right to terminate the agreement blancheHout judicial intervention, notblanchehstanding the right to be compensated for the costs, work, (partial) Delivery or other expenses made or delivered up tothat moment.

7.2 All invoices of Solero Trading forthcoming from the Agreement, are subject to a 30 day payment term, unless explicitly agreed upon otherwise in writing.
 7.3 If the invoice amount has not been entirely settled on the due date of the Invoice, Buyer will be in state default blancheHout requiring any further formal notice.
 7.4 Buyer is not entitled to deduct any discount, compensation or other cost blancheh the invoice amount. 6.5 If Buyer is in a state of default, Solero Trading has the right to suspend any Delivery of any Product up to the moment when Buyer has fulfilled all its obligations, after which a new Delivery moment will be determined at the discretion of Solero Trading.
 7.6 If Buyer defaults on its payment obligations, a minimum administration fee of € 50,00 excluding Sales tax will apply, as well as the legal commercial interest blancheh a minimum of 1% of the principal amount per month, all extrajudicial costs according to the Dutch national guideline 'Rapport Voorwerk II', all reasonably made costs made by Solero Trading in order to secure its claim, both judicial as extrajudicial and not limited to capped fees, as well as compensation for all damages suffered by Solero Trading as a result of e.g. but not limited to currency fluctuations, extra government levies or taxes, extra storage or transport costs or other costs forthcoming out of suspending the Delivery.
 7.7 If any additional costs do apply on top of the principle amount, any payment of Buyer, regardless of its own appointed sequence, will first be deducted of the additional costs, then the interest and finally the principle amount.

ARTICLE 8: LIABILITY

8.1 If Solero Trading would be liable to any claim; this liability is limited or excluded according to the provisions of this article.
 8.2 Solero Trading will never be liable for any occurring damages, if it has acted based on information provided by the Buyer that has proven to be inaccurate or incomplete.
 8.3 If Solero Trading would be liable in any case, the maximum amount for which Solero Trading would be liable is the principle amount of the Agreement that contains the liability situation, explicitly excluding previous or future Agreements.
 8.4 Solero Trading will never be liable for indirect damages such as but not limited to consequential damage, lost profits or loss of productivity. Solero Trading can only be held liable for direct damages.
 8.5 Direct damages are limited to: The reasonable costs made to determine the direct damage in economic terms and values, the reasonable costs made to correct the culpable failure of Solero Trading and the reasonable costs made to prevent or limit any further direct damages.
 8.6 Solero Trading will never be liable for errors, damages or defects that are consequential to behavior or actions of Buyer or third parties, or in case of force majeure, including but not limited to war, situations equal to war, riots and public disturbances, earthquakes, storms, flooding, fire, an act of God or any natural disasters, illness, blockades, the impossibility of transportation, strikes or any other impossibility to deliver as such, prohibitions enacted by the government or other authorized third parties. If such cases would occur, Solero Trading will inform the Buyer of this occurrence as soon as possible but possibly later than the Delivery moment and in writing, after which Solero Trading may choose to their fulfill its Delivery as soon as reasonably possible, or to terminate the Agreement.
 8.7 Blancheh the exception of what has been determined in the previous conditions concerning liability, Buyer will safeguard Solero Trading from any claims, actions, costs, losses or damages occurring from or related to the Delivery and/or the Products.

ARTICLE 9: RESERVATION OF OWNERSHIP

9.1 The Product will be the property of Solero Trading up to the moment on which Buyer has entirely met its obligations regarding to or forthcoming from of the Agreement.
 9.2 The Buyer is explicitly forbidden to encumber, pledge, transfer or in any way use for insurance, any Product for which the ownership has not yet been obtained.
 9.3 If Buyer fails to fulfill its obligations to Solero Trading, or if Buyer it in state of bankruptcy, payment moratorium or a similar state, or if he ceases his activities for a period of 30 consecutive days, Solero Trading is entitled, blancheHout requirement of judicial intervention, notice of default or timely notification, to recollect the Product, whereby Buyer is obliged to render its cooperation to this process.
 9.4 Our Solero O'Bravia is specially designed for sustainable outdoor use. It is possible however that small imperfections emerge after the installation of the parasol: wrinkles or a small difference in thickness of the fiber is inherent to a foldable parasol cloth. The reseller can't be held responsible for samll imperfections on the cloth. Requirements about the weight, water column, stiffness, thickness and colour fastness are determined, and guaranteed by the manufacturer.

ARTICLE 10: WARRANTIES

10.1 Buyer will receive a warranty on the Product safeguarding against manufacturing defects which are subject to the conditions as set forward in the warranty certificate. The warranty will be void if any defect is the result of Product abuse, negligence, vandalism, improper installation, accidents, exposure to abnormal weather conditions, color fading of polyester cloths or other causes which cannot be defined as a defect by Solero Trading.
 10.2 Defects to the Product are to be reported blanchehin a term of fourteen calendar days and in writing to Solero Trading.
 10.3 If the guarantee claim is granted by Solero Trading, it will provide Buyer blancheh replacing spare parts during the guarantee period.

ARTICLE 11: COMPETENT COURT AND JURISDICTION

11.1 Blancheh the explicit exclusion of all other jurisdictions, every Agreement is solely subject to Dutch law.
 11.2 All disputes blancheh regards to or forthcoming of the Agreement, proposal, Product or delivery between Solero Trading and Buyer will be solely decided on by the competent court in 's Hertogenbosch, the Netherlands, notblanchehstanding the right of Solero Trading to bring any case to the court in the city of Buyers location.
 11.3 A copy of the Dutch version of these Terms & Conditions has been filed blancheh the Dutch Chamber of Commerce under file number 17217199 and will always be provided to the Buyer before entering into the Agreement.

ARTICLE 12: COMPLAIN PROCESSING

Complaints about a product or service purchased at Solero Parasols can be filed at:
 Solero Parasols
 Industrieweg 210
 Netherlands
 5683 CH Best
 When filling a complaint, our e-mail address info@parasols.nl must be informed. The European Commission's online dispute resolution is also available for complaints. This is especially relevant if the Customer is a consumer living in another European country. File your complaint here: <http://ec.europa.eu/odr> When filling a complaint, our e-mail address info@parasols.nl must be informed.