

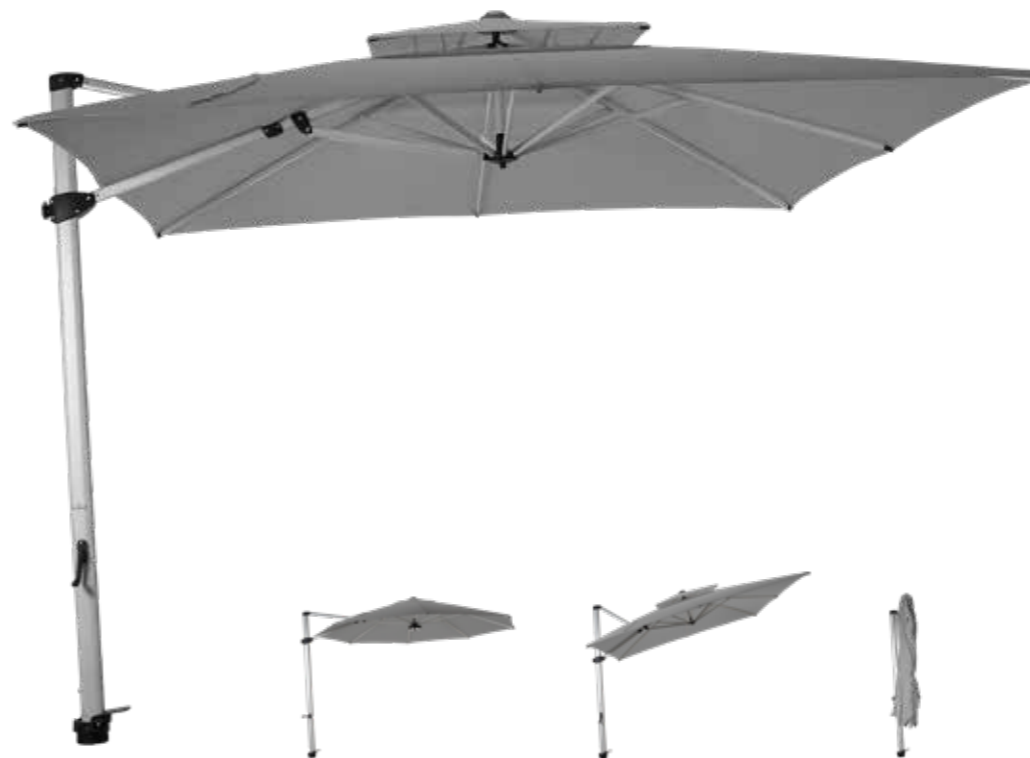

SOLERO® LATERNA PRO

Lounging, reading and relaxing on your terrace? Or enjoying those nice summer days with friends and family? The Laterna will bring your holiday to your own garden.

By using exclusively high quality materials we promise you'll enjoy your luxurious floating parasol for years to come. Due to its generous sizes (**300x300 cm or Ø 350 cm**) this parasol turns any outdoor area into a welcoming space for large and small groups. Despite its size, it's easy to handle and can be moved into any position with the one smooth move. Would you prefer not to have an unsightly pedestal or heavy tiles on your patio? This parasol can be anchored into the ground quickly and aesthetically.



ALWAYS UNDER TENSION

The Laterna is delivered with a silver frame and comes with a complimentary protective cover. You'll also receive a wireless, rechargeable free lighting! The Laterna parasol cloth is kept tight in a beautiful way by its integrated rib ends.

FOLLOW YOUR INTUITION

With this luxurious floating parasol you'll get the maximum ease of use in your garden. The parasol has an intuitive control rod that allows effortless opening, closing and tilting. You can also rotate the parasol 360 degrees.



WIND VENTILATION ROOF

You'll always stay cool under the Solero Laterna. The square version is outfitted with a special wind ventilation roof. The round version has a wind catcher as well, but this isn't lifted up as high from an esthetical point of view. On (too) hot days the canvas also releases heat instead of capturing it under the parasol. On top of that, this helps the parasol gain stability. When wind flows under the parasol it'll easily be released.

